

Digital Mass Flow Controller

Type 1179B / 1479B / 2179B

and

Digital Mass Flow Meter

179B

- Instruction Manual -

Copyright © 2003 by MKS Instruments Deutschland GmbH.

All rights reserved. No part of this work may be reproduced or transmitted in any form or by any means, electronic or mechanical, including photocopying and recording, or by any information storage or retrieval system, except as may be expressly permitted in writing by MKS Instruments.

Printed in the Federal Republic of Germany

Swagelok[®], VCR[®], and VCO[®] are registered trademarks of Swagelok Marketing Company, Solon, OH

Kalrez[®] and Viton[®] are registered trademarks of DuPont Dow Elastomers Inc., Wilmington, DE

NUPRO[®] is a registered trademark of Crawford Fitting Company, Solon, OH

Kel-F[®] is a registered trademark of 3M, Minneapolis, MN

Table of Contents

Mass Flow Controller Safety Information	9
Symbols Used in This Instruction Manual	9
Symbols Found on the Unit	10
Safety Procedures and Precautions	11
Chapter 1: General Information	13
Introduction	13
Overview of Versions	13
Options	14
Special versions	14
Power Supply and Readout Units	14
Profibus Version	14
Reliability	15
Instruction Manual	15
Contents	15
Conventions	15
Designations and Names	16
Chapter 2: Shipment	17
General	17
Unpacking	17
Unpacking Checklist	17
Analog Units	17
Profibus Units	18
Optional Accessories:	18
Label	19
Clean Room Packaging	19
Chapter 3: Connectors and Control Elements	21
Analog Units	21
Potentiometer ZERO	22
RESET Switch	22
Electrical Connector	23
1179B, Analog Unit	23

Profibus Units	24
RESET Switch	25
Address and Mode switch A/B	25
Status LED STS	25
Electrical Connectors	26
1179B, Profibus Units, Connector ANALOG	26
1179B, Profibus Units, Connector PROFIBUS	27
Chapter 4: Installation.....	29
General Requirements	29
Environmental.....	29
Location and Orientation	30
Protection against Dust and Water	31
Use of a Positive Shutoff Valve, e.g. Type 2179B	31
Leak Integrity	31
Pressure Drop Test	31
Dimensions.....	32
Type 179, 1179 and 1479, Analog and Profibus Units	32
Mounting Holes on 179, 1179, 1479 Analog and Profibus Units	33
Type 2179B, Analog and Profibus Units	34
Mounting Holes	35
Electrical Connections and Cables	36
Cables and Controllers by MKS	36
Power Supply / Readout Units of other Manufacturers.....	36
Non MKS Cables.....	37
Finishing the Installation.....	37
Chapter 5: Operation (Analog Units).....	39
Start Up the Mass Flow Controller/Meter	39
Zero Adjust	40
Override the Control Valve	41
Priority of Commands.....	41

Chapter 6: Operation (Profibus Units).....	43
Functions.....	43
Overview	43
Valve Override.....	44
Auto Zero.....	44
Alarm Limits.....	44
Temperature Measurement.....	44
Valve Drive Level	44
User Span / Gas Correction	45
User Zero	45
Filter.....	45
Gas Tables	45
Soft Start Rate.....	45
Start Up the Mass Flow Controller	46
Zeroing the Flow Controller	47
Zero Offset	47
Status LED STS	48
Address and Mode Switch A/B.....	48
Switch Assignment	48
Mode B	48
Setting an Address	49
Mode A	49
Zero Modes	49
PROFIBUS Protocol.....	50
Data Interface.....	50
Send Data	51
Small Receive Data.....	52
Full Receive Data	53
Small Setup	54
Full Setup	55
Small Diagnostics.....	57
Full Diagnostics	58
Calibration Table	60
PROFIBUS Setup.....	61
GSD Files Usage.....	61
Standard GSD File	62

Chapter 7: Theory of Operation.....	63
Technique of Measurement and Control, Electronics	63
Flow Path.....	64
Measurement Technique.....	64
Control Circuitry.....	64
Control Valve	65
Chapter 8: Gas Correction Factor (GCF)	67
The Gas Correction Factor (GCF):.....	67
How To Calculate the GCF for Pure Gases.....	67
How To Calculate the GCF for Gas Mixtures.....	68
Example.....	69
Mass Flow Rate at a Different Reference Temperature	69
Direct Reading of the Analog Output Signal	70
Chapter 9: MFC Sizing Guidelines	71
General.....	71
Determining the Flow Controller Range	72
Configurations for Low or High Differential Pressure.....	72
Chapter 10: Maintenance	73
General.....	73
Zero Adjustment	73
Checks and Recalibration	73
Profibus Support Kit	74
Customer Support	74
Troubleshooting.....	75
Chapter 11: Type 179B, 1179B, 1479B, 2179B (Comparison).....	77
Type 179B	77
Type 1179B	77
Type 1479B	77
Type 2179B	77
Pneumatic Positive Shutoff Valve	78
Appendix A: Product Specifications	79
Specifications	79
Environmental Specifications	80
Electrical Specifications.....	80
Physical Specifications.....	81

Appendix B: Model Codes.....	83
Model Code	83
Appendix C: Gas Correction Factors	87
Appendix D: Binary Code	91
MKS Worldwide Calibration & Service Centers	93

There is a declaration of contamination on the last page of this instruction manual.

List of Figures

Figure 1: Model Code Label	19
Figure 2: 1179B /1479B / 179B Side View	21
Figure 3: 1179B /1479B / 179B Connector Side	21
Figure 4: 1179B / 1479B / 179B Gas Inlet Side	22
Figure 5: 15-pol. connector	23
Figure 6: 1179B / 1479B / 179B Side View	24
Figure 7: 1179B / 1479B / 179B Connector Side	24
Figure 8: 1179B / 1479B / 179B Gas Inlet Side	25
Figure 9: 9-pol. Connector.....	26
Figure 10: Profibus Connector	27
Figure 11: 1179B 1479B / 179B Dimensions (Side)	32
Figure 12: Dimensions (Inlet/Outlet side).....	33
Figure 13: Mounting Holes on 1179B, 1479B, 179B.....	33
Figure 14: Type 2179B, Side.....	34
Figure 15: Type 2179B, Connector Side.....	35
Figure 16: Base Plate, Dimensions and Mounting Holes.....	35
Figure 17: Adress and Mode Switch Map A/B	48
Figure 18: Assembly.....	63
Figure 19: Voltage Divider.....	70

List of Tables

Table 1: Definition of Symbols Found on the Unit.....	10
Table 2: MKS Cables.....	36
Table 3: Troubleshooting.....	76
Table 4: Ordering Code - Ranges	84
Table 5: Ordering Code - Fittings.....	84
Table 6: Ordering Code - Valves.....	85
Table 7: Ordering Code - Connectors	85
Table 8: Ordering Code - Seals.....	85
Table 9: Binary Code.....	91

Mass Flow Controller Safety Information

Symbols Used in This Instruction Manual

Definitions of WARNING, CAUTION, and NOTE messages used throughout the manual.

Warning



The **WARNING** sign denotes a hazard to personnel. It calls attention to a procedure, practice, condition, or the like, which, if not correctly performed or adhered to, could result in injury to personnel.

Caution



The **CAUTION** sign denotes a hazard to equipment. It calls attention to an operating procedure, practice, or the like, which, if not correctly performed or adhered to, could result in damage to or destruction of all or part of the product.

Note



The **NOTE** sign denotes important information. It calls attention to a procedure, practice, condition, or the like, which is essential to highlight.

Symbols Found on the Unit

The following table describes symbols that may be found on the unit.















Definition of Symbols Found on the Unit			
			
On (Supply) IEC 417, No.5007	Off (Supply) IEC 417, No.5008	Earth (ground) IEC 417, No.5017	Protective earth (ground) IEC 417, No.5019
			
Frame or chassis IEC 417, No.5020	Equipotentiality IEC 417, No.5021	Direct current IEC 417, No.5031	Alternating current IEC 417, No.5032
			
Both direct and alternating current IEC 417, No.5033-a	Class II equipment IEC 417, No.5172-a	Three phase alternating current IEC 617-2 No.020206	
			
Caution, refer to accompanying documents ISO 3864, No.B.3.1	Caution, risk of electric shock ISO 3864, No.B.3.6	Caution, hot surface IEC 417, No.5041	

Table 1: Definition of Symbols Found on the Unit

Safety Procedures and Precautions

The following general safety precautions must be observed during all phases of operation of this instrument. Failure to comply with these precautions or with specific warnings elsewhere in this manual violates safety standards of intended use of the instrument and may impair the protection provided by the equipment. MKS Instruments, Inc. assumes no liability for the customer's failure to comply with these requirements.

DO NOT SUBSTITUTE PARTS OR MODIFY INSTRUMENT

Do not install substitute parts or perform any unauthorized modification to the instrument. Return the instrument to an MKS Calibration and Service Center for service and repair to ensure that all safety features are maintained.

SERVICE BY QUALIFIED PERSONNEL ONLY

Operating personnel must not attempt component replacement and internal adjustments. Any service must be made by qualified service personnel only.

USE CAUTION WHEN OPERATING WITH HAZARDOUS MATERIALS

If hazardous materials are used, observe the proper safety precautions, completely purge the instrument when necessary, and ensure that the material used is compatible with the wetted materials in this product, including any sealing materials.

PURGE THE INSTRUMENT

After installing the unit, or before removing it from a system, purge the unit completely with a clean, dry gas to eliminate all traces of the previously used flow material.

USE PROPER PROCEDURES WHEN PURGING

This instrument must be purged under a ventilation hood, and gloves must be worn for protection.

DO NOT OPERATE IN AN EXPLOSIVE ENVIRONMENT

To avoid explosion, do not operate this product in an explosive environment unless it has been specifically certified for such operation.

USE PROPER FITTINGS AND TIGHTENING PROCEDURES

All instrument fittings must be consistent with instrument specifications, and compatible with the intended use of the instrument. Assemble and tighten fittings according to manufacturer's directions.

CHECK FOR LEAK-TIGHT FITTINGS

Carefully check all vacuum component connections to ensure leak-tight installation.

OPERATE AT SAFE INLET PRESSURES

Never operate at pressures higher than the rated maximum pressure (refer to the product specifications for the maximum allowable pressure).

INSTALL A SUITABLE BURST DISC

When operating from a pressurized gas source, install a suitable burst disc in the vacuum system to prevent system explosion should the system pressure rise.

KEEP THE UNIT FREE OF CONTAMINANTS

Do not allow contaminants to enter the unit before or during use. Contamination such as dust, dirt, lint, glass chips, and metal chips may permanently damage the unit or contaminate the process.

ALLOW THE UNIT TO WARM UP

If the unit is used to control dangerous gases, they should not be applied before the unit has completely warmed up. Use a positive shutoff valve to ensure that no erroneous flow can occur during warm up.

Chapter 1: General Information

Introduction

The digital mass flow controllers of the 1179B series accurately measure and control the mass flow rate of gases. The type 179B of this series is a mass flow meter for mass flow measurement only and is completely metal sealed.

Based upon an patented* MKS measurement technique, these instruments use a laminar flow device whose precise indication of mass flow is achieved through the use of a laminar bypass element in parallel with a sensor tube. The 1179, 1479 and 2179 digital controllers use a PID algorithm which compares the flow signal with an external setpoint command, thus creating a control signal which is applied to a solenoid driven control valve to set the desired flow rate. The controllers also feature in the analog mode the ability to accept TTL level commands to remotely open and close the control valve. The control valve is located at the outlet of the meter section, also inside the metal instrument housing. The metal cover plus the RF bypass capacitors virtually eliminate RFI and EMI interference.

The flow signal as derived from the sensor and also an analog setpoint signal are digitalized. Therefore linearization, flow control and handling of all other signals and commands is operated by the microcomputer, in both digital and analog versions of the B series. This provides best accuracy and optimizes the controller's response and stability.

The 1179,1479 controller and 179 meter have a three-inch footprint. The type 2179 has a positive shutoff valve, pneumatically driven and close coupled to the controller outlet.

Overview of Versions

Type	Function	Features
179B	Mass Flow Meter	Standard unit, all metal sealed, full scale ranges from 5 to 20 000 sccm
1179B	Mass Flow Controller	Standard unit, one elastomer seal, all other sealing metal, full scale ranges same as Type 179B, fully closing control valve, override function
1479B	Mass Flow Controller	Same as 1179B but all metal sealed
2179B	Mass Flow Controller	Same as 1179B but with positive shutoff valve at outlet side

* US Patent No 5461913

Options

- Analog version (digital electronic with analog interfacing)
- Profibus version
- Full scale range: 10, 20, 50, 100, 200, 500, 1000, 2000, 5000, 10.000, 20.000 sccm (N₂-equivalent);
- Fittings: Cajon[®] 4-VCR[®] male, Cajon[®] 4-VCO[®] male, 6 mm and 1/4" Swagelok[®], DN16KF

For other fittings and ranges contact MKS please.

Special versions

There are many variations of the above listed versions and options possible, for example

- with filter mounted at inlet
- with all metal valve plug
- low pressure drop versions for low inlet pressure or small differential pressure applications, e.g. combination with vaporizers or use with air sampling pumps etc.
- combinations (Gas Sticks) with filters, pneumatic shutoff valves at inlet and/or outlet, purge fitting, mini-pressure transducers etc.

The control valve of all mass flow controllers is a normally closed (NC) valve.

Power Supply and Readout Units

The analog versions of the 1179B series can interface to complementary MKS equipment which are available as single channel, dual channel, four and eight channel units to display the flow signal and to provide the power and set point commands. Almost all control units are equipped with serial interface. Refer to the corresponding manuals for requirements and instructions.

Profibus Version

The particular features of units with Profibus interface, setup and control are described in *Chapter 6, Operation*.

Note: All Profibus versions can also be operated in analog manner, e.g. for diagnosis purposes. The analog interface and Profibus interface connector are described in *Chapter 3 Overview*.

The mechanical features and installation are the same as for the analog version.

Non-Compatibility

Profibus versions 179A, 1179A, 1479A and 2179A measure temperature in K, whereas the B-series described in this manual measure temperature in °C.

Reliability

To help provide excellent reliability, the design contains a low mechanical and electronic components count and has successfully passed the following tests:

- STRIFE, including temperature cycling, humidity and vibration (sine and random tests)

and with an overall metal braided shielded cable, properly grounded at both ends:

- CE Compliance - The instrument complies to EN 61326-2-3 with the requirements for industrial applications with continuous not monitored operation. Braided shielded cables must be used. The PROFIBUS cable must be qualified.

Contents

This manual provides instructions on setup, installation, operation and service of:

- Mass flow controller 1179B / analog version
- Mass flow controller 1179B / Profibus version
- Mass flow controller 1479B / Profibus version only*
- Mass flow controller 2179B / analog version
- Mass flow controller 2179B / Profibus version
- Mass flow meter 179B / analog version
- Mass flow meter 179B / Profibus version

Conventions

If not explicitly expressed differently at the respective place in this handbook all data are referenced to:

- Temperature in °C
- Gas type is nitrogen N₂
- Pressure
in mbar or bar with index (a) relates to absolute pressure and whereas index (g) stands for gage pressure, related to atmosphere.

Example: 1,7 bar (g) = 1,7 bar overpressure versus atmosphere (gage pressure).
0,5 bar (a) = 500 mbar absolute pressure.

- Flow rates
are given in sccm** or slm*** related to nitrogen or dry air.

* for analog version order type 1479A

** 1 sccm = 1 standard cm³ / min ; Standard conditions: 1013,25 mbar and 0 °C

*** 1 slm = 1 standard liter / min = 1000 sccm

Designations and Names

Throughout this handbook all three types of mass flow controllers, namely 1179B, 1479B and 2179B will be expressed by type 1179B in common. The types 1479B and 2179B will only be mentioned by their specific name where it is necessary to avoid confusion.

The mass flow meter 179B will only be mentioned in particular where this is necessary, else wise the instructions for the 1179B also apply for the meter 179B.

The specific features and characteristics of the types 1479B, 2179B and 179B are described in extra chapters in this manual.

Chapter 2: Shipment

General

Unpacking

MKS has carefully packed each unit so that it will reach you in perfect operating order. Upon receiving the unit, however, you should check for defects, cracks, broken connectors, damaged cables etc., to be certain that damage has not occurred during shipment.

Note

Do *not* discard any packing materials until you have completed your inspection and are sure the unit arrived safely.

If you find any damage, please notify your carrier and MKS immediately. If it is necessary to return the unit to MKS, obtain an ERA Number (Equipment Return Authorization Number) from the MKS Service Center before shipping. Please refer to the inside of the back cover of this manual for a list of MKS Calibration and Service Centers.

Unpacking Checklist

Analog Units

Mass flow controller 1179B (type 1479B, 2179B or mass flow monitor 179B respectively)

Accessory kit ZB-30 consisting of

- Mating connector D-type; 15 pin female
- 2 mounting screws #8-32 UNF (MKS part no. 160-3973)

Manual (this book)

Calibration sheet

Profibus Units

Mass flow controller 1179B (type 1479B, 2179B or mass flow monitor 179B respectively)

Accessory kit ZB-27 consisting of

- Mating connector D-type; 9 pin female
- Mating connector D-type; 9 pin male
- 2 mounting screws #8-32 UNF (MKS part no. 160-3973)

GSD file (3,5" disc)

Manual (this book)

Calibration sheet

Note: The mounting screws are not needed for units with mounting plates.

Optional Accessories:

Control units, power supplies, readout units

Cable

Water&Dust protection cap type WPC 63

for use in humid or dusty environments

Profibus Support Kit

for units with Profibus only

Ordering Code. 1179-PB-SUPPORT

Consisting of:

1 Disc 3,5"

1 RS 232 cable

1 converter RS232/RS485

1 instructions

etc.

Label

The label shows the following information:

See figure 1 as an example:

Model code	1179B, for other codes ref. to appendix B
Sealing	Viton
Range	200 sccm
Gas type	N2 (the range is related to this gas)
Serial number	454145G20
CE mark	CE
Manufacturer	MKS Instruments Deutschland GmbH



Figure 1: Model Code Label

Across the housing and the meter/controller body there is an extra label to avoid access to the inside by unauthorized people. Broken or removed label means lost of any warranty.

Clean Room Packaging

It is possible to get the flow controllers and meters delivered in clean room packaging (as an option). When unpacking, follow these steps, please:

1. Remove the outer bag in an ante room (garmenting room) or transfer box. Do not allow this outer bag to enter the clean room.
2. Wipe down the exterior of the inner bag with a clean room wipe. This step reduces the contamination introduced into the clean room.
3. Remove the inner bag in the clean room.

This page intentionally left blank

Chapter 3: Connectors and Control Elements

Analog Units

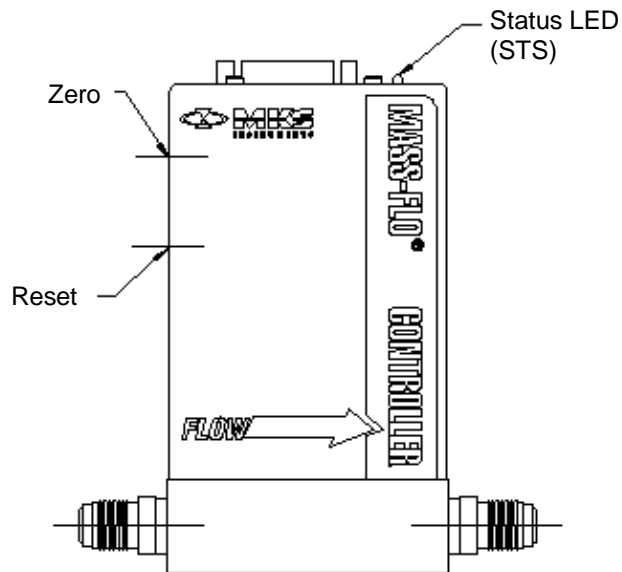

Figure 2: 1179B /1479B / 179B Side View

(Imprint on type 179B: MASS-FLO METER)

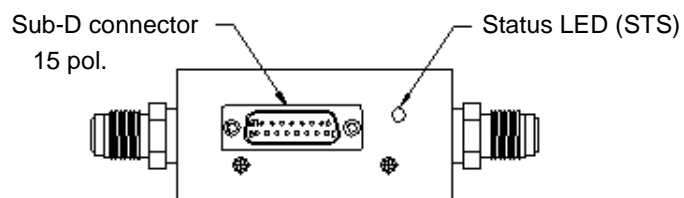

Figure 3: 1179B /1479B / 179B Connector Side

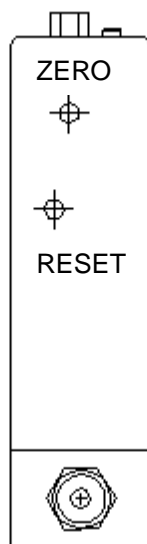

Figure 4: 1179B / 1479B / 179B Gas Inlet Side

Potentiometer ZERO

Use this 25 turn potentiometer to adjust the signal output to zero.

Refer to *Chapter 5, Operation (Analog Units)*, section *Zero Adjust*.

RESET Switch

After pressing the RESET key the unit performs a self check cycle and a reset. The same procedure is done after power on. During the cycle the two colour LED, labeled STS, changes its colour a few times between red and green.

Finally the LED changes to green, indicating that self test cycle and reset have been completed successfully.

Electrical Connector

1179B, Analog Unit

(15 pol. Sub-D, male)

Pin	± 15 V Supply	24 V Supply	Note
1	Reserved	Reserved	
2	Flow Signal (0 to +5 V)	Flow Signal (0 to +5 V)	Referenced to pin 11 and 12
3	Valve Close ¹	Valve Close ¹	Connect to pin 5 to activate
4	Valve Open ¹	Valve Open ¹	
5	± 15 V Supply Common	Signal Common	
6	- 15 V Supply	+ 24 V Supply Common	
7	+ 15 V Supply	+24 V	
8	Setpoint Input ¹ (0 to +5 V)	Setpoint Input ¹ (0 to +5 V)	Referenced to pin 11 and 12
9	NC	NC	
10	NC	NC	
11	Signal Common	Signal Common	
12	Signal Common	Signal Common	
13	NC	NC	
14	NC	NC	
15	Chassis Ground	Chassis Ground	Shield, Case

Figure 5: 15-pol. connector

For use with control units from MKS Instruments (PR 4000, 647 etc.) we recommend to use the standard cables of the manufacturer.

¹ Not applicable with mass flow meter 179B

Note



Any appropriate 0 to +5 V signal of less than 20 k Ω source impedance can be used to supply a set point signal to pin 8.

Profibus Units

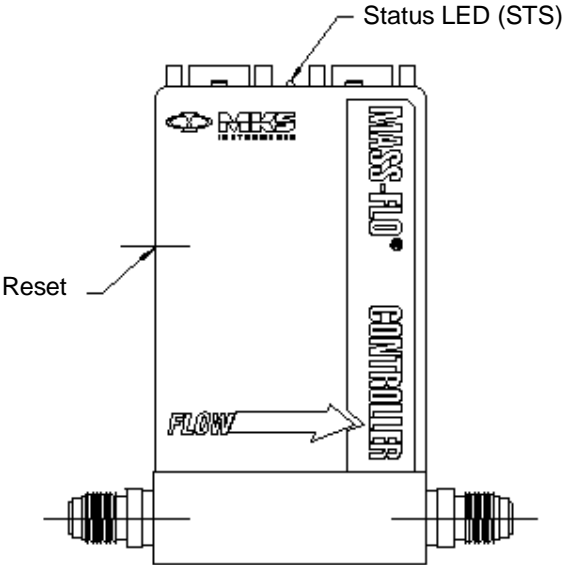

Figure 6: 1179B / 1479B / 179B Side View

(Imprint on type 179B: MASS-FLO METER)

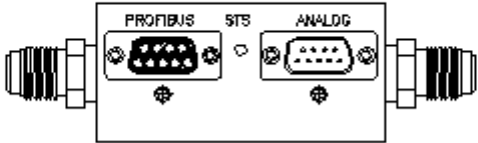

Figure 7: 1179B / 1479B / 179B Connector Side

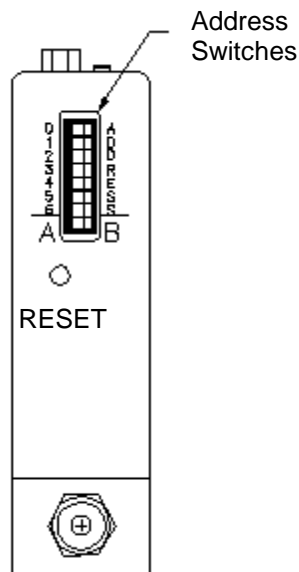

Figure 8: 1179B / 1479B / 179B Gas Inlet Side

RESET Switch

After pressing the RESET key the unit performs a self check cycle and a reset. The same procedure is done after power on. During the cycle the two colour LED, labeled STS, changes its colour a few times between red and green.

Finally the LED changes to green, indicating that self test cycle and reset have been completed successfully.

Address and Mode switch A/B

This switch selects either analog or Profibus mode. In Profibus mode you can set the address of the unit, in analog mode the mass flow controller requires an analog setpoint voltage.

Refer to *Chapter 6, Operation (Profibus Units)*, for detailed description.

Status LED STS

The Status LED provides two functions: Indicates the status of the instrument and indicates the Profibus address, at power on or on request.

The LED STS is explained more detailed in *Chapter 6, Operation (Profibus Units)*.

Electrical Connectors

1179B, Profibus Units, Connector ANALOG

(9 pol. Sub-D, male)

Pin	± 15 V Supply	24 V Supply	Note
1	Valve Open / Valve Close ^{1,2}	Valve Open / Valve Close ^{2,3}	
2	Flow Signal (0 to +5 V)	Analog operation not possible	Referenced to pin 7 and 8
3	+ 15 V Supply	+ 24 V Supply	
4	± 15 V Common	Signal Common	
5	- 15 V Supply	24 V Common	
6	Setpoint Input ²	Analog operation not possible	Referenced to pin 7 and 8
7	Signal Common	-	
8	Signal Common	-	
9	Reserved	Reserved	

Figure 9: 9-pol. Connector

For the use of the Profibus version in analog mode is a +/- 15 VDC power supply required. For the use in digital mode a +/- 15 VDC or a 24 VDC power supply is sufficient.

This connector does not provide a particular pin for connection to the case. Connect the cable shield to the connector housing for grounding.

¹ To close the valve connect pin 1 to pin 5 (-15 V);
To open the valve apply + 5 V to pin 1 (referenced to pin 7 or 8).

² Not applicable with mass flow meter 179B

³ To close the valve connect pin 1 to pin 4;
To open the valve apply + 5 V to pin 1 (referenced to pin 7 or 8).

1179B, Profibus Units, Connector PROFIBUS**(9 pol. Sub-D, female)**

Pin	Signal	Note
1	NC	
2	NC	
3	RXD / TXD – P	Bus positive
4	CNTR – P	Control for Repeater, positive
5	DGND	Digital Ground
6	VP	Power Supply (5V)
7	NC	
8	RXD / TXP – N	Bus negative
9	NC	

Figure 10: Profibus Connector

This page intentionally left blank

Chapter 4: Installation

General Requirements

Environmental

Follow the guidelines below when installing and using your mass flow controller.

1. Maintain the normal operating temperature between 0° - 50°C (32° and 122°F).
2. Observe the pressure limits
 - Maximum gas inlet pressure is 150 psig.
 - Operational differential pressure is:
 - 10 to 40 psid for ≤ 5000 sccm units
 - 15 to 40 psid for 10000 to 20000 sccm units.
 - The standard orifice is sized for control over this range with the outlet atmospheric pressure.
3. Two kinds of power supply are possible (applies to all units):
 - ± 15 V ($\pm 5\%$)
 - or
 - 24 V (20,5 to 31,5 V)¹
 - Current: ca. 200 mA at startup, type. 100 mA at steady state
4. Allow minimum 15 minutes for warm-up time for analog units as well as for units with Profibus.
5. Use high purity gas to purge the instrument.
6. The use of a filter upstream of the mass flow controller is recommended, if enough pressure is available.

Refer also to *Appendix A, Product Specifications* for other possible precautions and restrictions.

¹ For the use of the Profibus version in analog mode is a +/- 15 VDC power supply required. For the use in digital mode a +/- 15 VDC or a 24 VDC power supply is sufficient.

Location and Orientation

1. Set the controller into position where it will be connected to a gas supply.
Placement of flow components in an orientation other than that in which they were calibrated (typically horizontal) may cause a small zero shift. The zero offset can be removed according to the instructions in *Chapter 5, Zero Adjust* if an analog unit is used or in *Chapter 6, Zeroing the Flow Controller* if a Profibus unit is used.
2. Install the flow controller in the gas stream such that the flow will be in the direction of the arrow on the side of the controller.
Take into consideration the specified leak through the closed control valve in case of a mass flow controller. The specified value refers to new and unused units but may change during operation by age, cycles, temperature and gas. To achieve best possible leak tightness we strongly recommend the use of positive shut off valves. An optimum solution is the type 2179, which employs a pneumatically driven shut off valve, close coupled to the flow controller's outlet to minimize dead volume.
3. The normal position is horizontal, the electrical connector pointing upwards or vertical with flow direction either upwards or downwards.
It is possible to mount the units the way that the connector points downwards but control performance and valve leak can be affected. This applies especially to units with higher flow ranges. Therefore the 'ceiling mount attitude' should be avoided.
4. Allow adequate clearance for the tubing. Take into account when designing the plumbing that a unit may be removed later, e.g. for service or maintenance.
To de-install units with metal ferrule compression fittings (for example Swagelok) the tubing must be moved away some millimeters in axial direction whereas VCR fittings allow the instrument to be removed sideways also out from complexive and stiff plumbing systems.
5. Allow adequate clearance for the cable connector (two cable connectors in case of Profibus version).
Straight, shielded connectors need about 75 mm clearance.
Right-angle connectors require about 50 mm space.
6. Position the unit to provide access to the zero potentiometer, in case of Profibus units access to the dip switch bank and the RESET button:
Potentiometer or DIP-Switch / Button are located at the inlet side of the housing.
Make sure that the status LED is visible when installing units with Profibus.

Protection against Dust and Water

MKS Instruments offers a protection set, consisting of an elastic cover for the cable/connector access plus an adhesive tape to seal the gap between the housing and the body.

Refer to *Chapter 2, Optional Accessories*, or contact your MKS service center.

Use of a Positive Shutoff Valve, e.g. Type 2179B

Make sure that there is enough space for the pneumatic air inlet. Check also for available space if a valve position switch or pilot valve shall be installed.

Leak Integrity

We recommend to check tightness of all ports and connections of the plumbing with a helium leak detector.

Pressure Drop Test

If a leak check at high pressure is intended then check for the highest allowable pressure for all parts involved. Example: If a pressure based leak check at 5 bar (g) is done you will damage a pressure transducer in the line if it is limited to 3,5 bar (g). In this case the pressure transducer (or whatever component is affected) must be removed or protected by a suitable valve.

Dimensions

Type 179, 1179 and 1479, Analog and Profibus Units

The overall outline dimensions (length, width, height) are identical for both the analog and Profibus Units.

(All dimensions are listed in millimeters. Conversion: 1 inch = 25,4 mm)

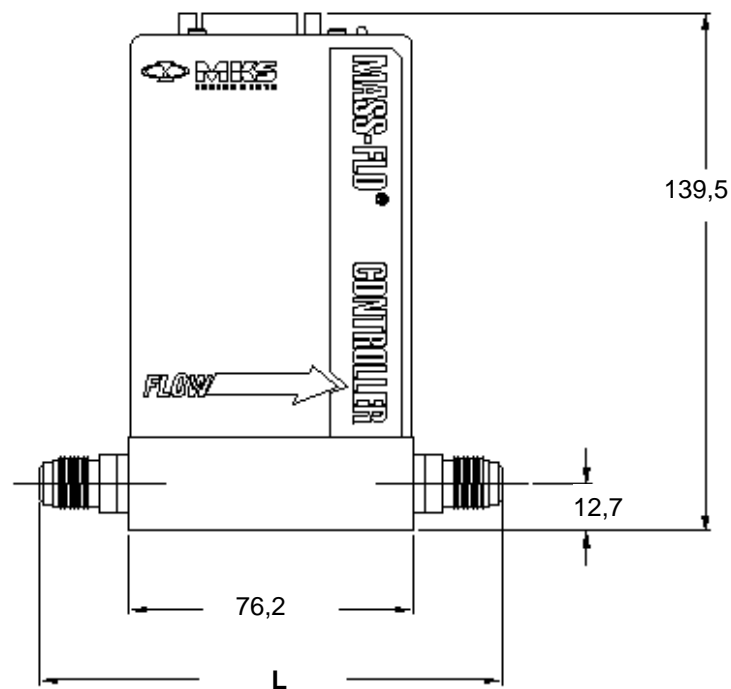

Figure 11: 1179B 1479B / 179B Dimensions (Side)
(Shown: analog unit; Imprint on type 179B: MASS-FLO METER)

Fittings (compatible)	L
4 VCR	123,9
4 VCO	115,8
8 VCR	133,7
¼" Swagelok*	112,7
6 mm Swagelok*	112,7
DN 16 KF	124,5
*) without nuts and ferrules	

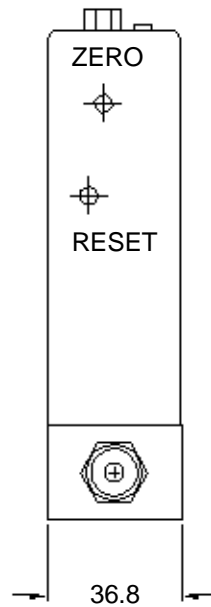

Figure 12: Dimensions (Inlet/Outlet side)

Mounting Holes on 179, 1179, 1479 Analog and Profibus Units

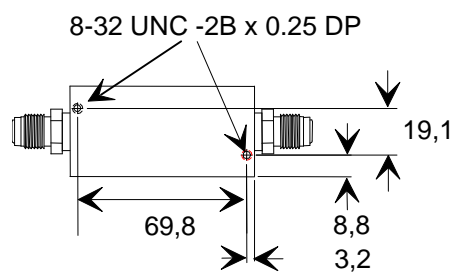

Figure 13: Mounting Holes on 1179B, 1479B, 179B

Type 2179B, Analog and Profibus Units

The type 2179 consists of a type 1179 flow controller configured with a positive shutoff valve downstream. The unit is completely mounted on a base plate (MKS p/n 1100299-P1). The four mounting holes, 6 mm diameter, in the base plate allow safe mounting in the system.

The shutoff valve is pneumatically operated. The inlet fitting for the compressed air is 1/8 NPT size, located on top of the actuator.

(Shown: Analog Unit)

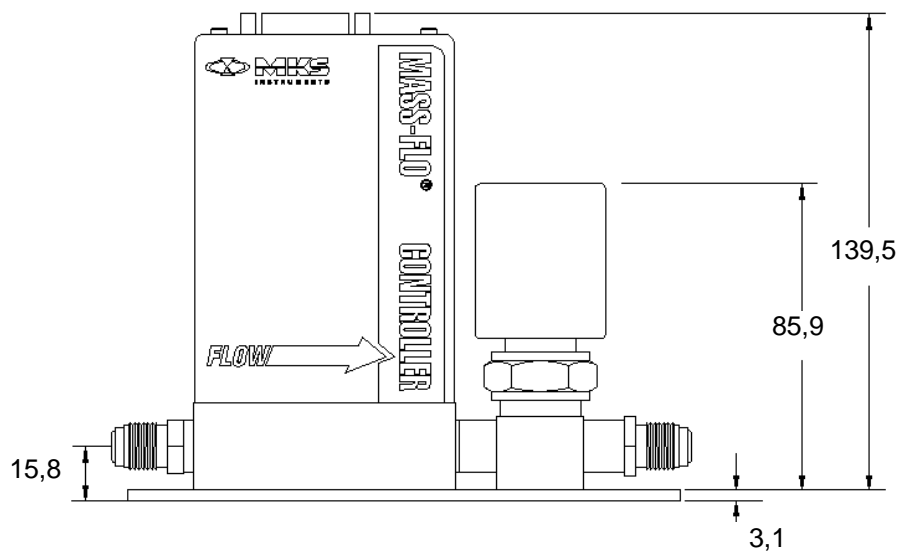

Figure 14: Type 2179B, Side

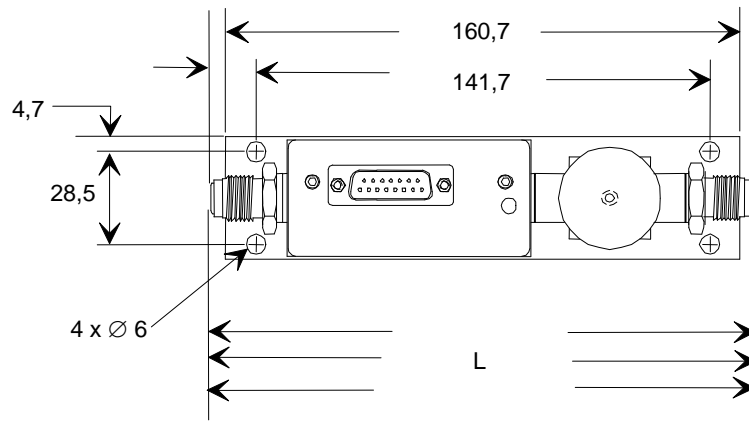

Figure 15: Type 2179B, Connector Side

Fittings (compatible)	L
4 VCR	170,4
4 VCO	162,3
¼" Swagelok*	159,2
6 mm Swagelok*	159,2
*) without nuts and ferrules	

Mounting Holes

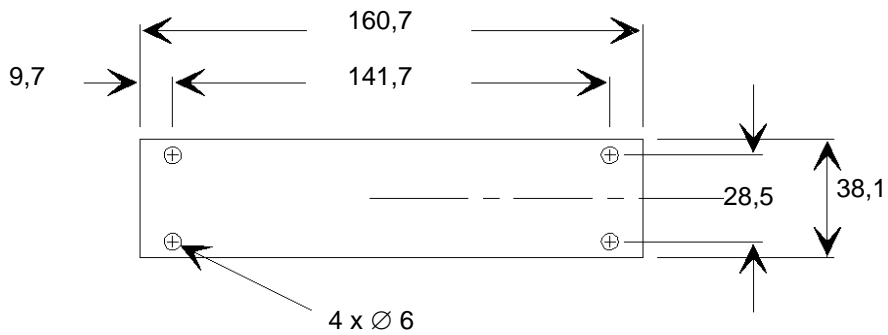

Figure 16: Base Plate, Dimensions and Mounting Holes

Electrical Connections and Cables

The units comply with the European standards and thus they are labelled with the CE-mark. To fulfill the above listed guidelines it is mandatory to use the appropriate interconnection cables.

Note



EMC Directive Requirements according to 2004/108/EC:

The instrument complies to EN 61326-2-2 with the requirements for industrial applications. Braided shielded cables must be used.

The PROFIBUS cable must be qualified.

We recommend to use the cables offered by MKS Instruments.

Cables which are in compliance with the CE guidelines are marked with an „E“ or „S“ (example: CB259E-... or CB259S-...).

Cables and Controllers by MKS

For use of the analog versions of the types 179B, 1179B, 1479B or 2179B with controllers, power supplies, readout units etc. by MKS standard cables are available.

Flow Controller/Meter	Control Unit	
(Analog Version)	Sub D 15-polig	Flying Leads
Sub D 15 pin	CBE259-5	CBE259-6

Table 2: MKS Cables

Power Supply / Readout Units of other Manufacturers

Should you use power supplies / readout units of manufacturers other than MKS then make sure that these units fulfill the electrical specifications for use with the mass flow controllers/meters as described herein. Refer to *Appendix A, Product Specifications*.

Non MKS Cables

Requirements

Should you choose to manufacture your own cables, follow the guidelines listed below:

1. The cable must have a braided shield, covering all wires. Neither aluminium foil nor spiral shielding will be as effective: using either may nullify regulatory compliance.
2. The connectors must have a metal case which has direct contact to the cable's shield on the whole circumference of the cable.
3. With very few exceptions, the connector(s) must make good contact (typical $0,01\Omega$ or less) to the device's case (ground). The case also must be properly grounded.
4. When selecting the cable, consider:
 - a) The voltage ratings.
 - b) The cumulative I^2R heating of all the conductors (keep them safely cool).
 - c) The IR drop of the conductors, so that adequate power or signal voltage gets to the device.
 - d) The capacitance and inductance of cables which are handling fast signals
 - e) If there are specific requirements when supply units etc of other manufacturers are used

Finishing the Installation

1. Check all fittings and flanges for leaks.
Do not proceed with the next step until you have not made sure that there are no leaks.
2. Connect the interface cable(s) to the mass flow controller.
Connect the other end of the cable to the power supply/control electronics.
Check all electrical connections.

This ends the mass flow controller's installation.

This page intentionally left blank

Chapter 5: Operation (Analog Units)

Start Up the Mass Flow Controller/Meter

1. After you have successfully checked all mechanical and electrical connections and when you are certain that there is no gas leakage, then power can be applied to the mass flow controller or to the flow meter respectively.

The first start up should be done preferably using non-critical gas. This could be for example nitrogen or dry air (if there are no reactive residuals in the plumbing system) or any inert gas.

2. Switch on the power supply.

When power is first applied, the output signal jumps to + 4...5 V.

The unit performs automatically a reset, indicated by the red/green blinking status LED. Finally the LED changes to green light which indicates that the electronic circuitry is ready for use.

You can monitor the flow output signal as the instruments stabilizes and the output approaches zero. Approximately 15 minutes after power up the signal should be stable within some millivolts close to zero.

Note

Do not use dangerous gases for the first start up. Use a non-critical gas, for example the gas which serves for purging.

Note

If the instrument is being used to control dangerous gases, be sure that the system is fully warmed *up* before applying gases to the system. You may choose to install a positive shutoff valve to prevent inadvertent gas flow during the warm-up period.

Once the instrument is completely warmed up, you can proceed to zero the unit as required.

Zero Adjust

1. If no gas is flowing and the mass flow controller has stabilized (ref. to *Appendix A, Specifications, Warm Up*) the flow output signal should be zeroed by means of the potentiometer ZERO which is located at the gas inlet side of the unit.

Note

Zeroing should be done only on units that are installed in final position.

2. When using a control unit by MKS then you should use the zeroing means there. If the control unit does not provide enough compensation range then the potentiometer ZERO at the mass flow unit must be used.

Note

If a pressure difference exists at the mass flow control unit then a small flow might be generated even if the integrated control valve is closed. This is more likely with special units for low inlet pressures . Do not adjust the flow signal then to zero value because it is a real flow but use a positive shutoff valve to definitely stop the flow. Finally with flow completely stopped you should adjust the flow signal to zero.

3. Periodically check the zero adjustment of the unit, e.g. on maintenance intervals. The zero adjustment is affected by thermal effects and especially by contamination.

Beside of the need for measurements of highest accuracy the zero signal is very important for diagnosing the flow sensor and the control valve.

Override the Control Valve

The valve override feature enables the control valve to be fully opened (purged) or closed independent of the set point command signal:

To open the valve, apply a TTL low to pin 4 or connect pin 4 to pin 5 (analog ground).

To close the valve, apply a TTL low to pin 3 or connect pin 3 to pin 5 (analog ground).

Priority of Commands

The 1179 flow controller executes commands based on a hierarchical command structure. The highest priority command is Valve Open, followed by Valve Close, and finally the Set Point Control. Therefore, if the flow controller is operating under Set Point Control, you can send a Valve Open command to force the valve to the full open position.

Note



When both the Valve Close and Valve Open pins are pulled down, the Valve Open command takes precedence and the valve is moved to the open position.

This page intentionally left blank

Chapter 6: Operation (Profibus Units)

Functions

Beside the normal flow control mode the units equipped with Profibus provide a number of helpful functions and useful information.

Overview

- Valve Override
- Auto Zero
- Totalizer, gas counter
- Gas Correction
- 15 Calibration Tables, 15 points each
- 4 Limit Alarms
- Run Hours Counter
- Remaining Time to Calibration Observation (Calibration Cycle Count Down)
- Temperature Measurement
- Valve Drive Level
- Status LED
- Signal Filter (flow signal)
- User Span setting
- User Zero setting
- User Tag

Report Functions:

Calibration Date, Type, Model, Manufacturer, Serial No., Firmware/Hardware Revision, Product Code, Date of Factory Calibration, Full Scale Range, Engineering Unit, Standard Temperature Standard Pressure, Valve Type, Valve Power Off Mode.

Valve Override

By means of an analog override signal applied to the respective pins at the connector ANALOG the control valve can be driven completely open or closed, independent of the setpoint command signal (only in analog mode). Refer to figure 9 and its explanations for the detailed description.

In Profibus mode the override however is only possible via the bus:

Set the parameter VALVE_OVERRIDE to NORMAL to allow the mass flow controller establishing a flow in accordance to the setpoint command FLOW_SETPOINT.

Set the parameter VALVE_OVERRIDE to FLOW_OFF to completely close the control valve.

Set the parameter VALVE_OVERRIDE to PURGE to completely open the control valve. This command may be used to purge or vent the instrument or the system.

Auto Zero

If VALVE_OVERRIDE is equal to FLOW_OFF and THERMAL_MASS_FLOW_RATE is smaller than 5 % of full scale, the flag AUTOZERO (0 to 1 transition) will take the actual sensor signal as zero and will subtract this value from all future measurements (refer also to USER_ZERO).

Alarm Limits

LOW_TRIP_POINT and HIGH_TRIP_POINT define the limits for LOW_LIMIT_ALARM and HIGH_LIMIT_ALARM flags. Consider that there is a 0.5% hysteresis for each limit switch. The hysteresis of 0.5% is divided in a slope 2.5% above and an other slope 2.5% below the defined limit.

Temperature Measurement

The internal temperature of the device is measured in °C and given as INTERNAL_TEMP.

Valve Drive Level

The position of the valve is given in VALVE_DRIVE_LEVEL. 0% means that the valve is closed and 100% means that the valve is fully opened (e.g. at the PURGE command).

A typical value under normal operating conditions is 40...60 % with new units. The value depends on many parameters, e.g. pressure conditions, temperature, contamination, age etc., and may change also during operation even at the same flow rate.

User Span / Gas Correction

For tuning the flow controller's accuracy the USER_SPAN parameter should be used and for application of a specific gas the nominal full scale (e.g. N₂) may be multiplied by the GCF of the gas and the parameter FULL_SCALE_RNG may be set with the result. Another option is to set the parameter GAS_CORRECTION to the GCF of the gas (full functionality only).

User Zero

The parameter USER_ZERO may be set to the flow sensors offset. (See also *AUTO ZERO*)

Filter

The filter is a single-pole low pass filter. The parameter that the user can adjust is the settling time of the filter (FILTER_SETTLING). E.g. if a step input (magnitude 100) is applied to the filter with a settling time of 100 second, the response out of the filter will be within 2% of the final value (98%) in 100 second. The default value is 0 seconds (no filtering).

Gas Tables

Gas tables may be switched off by setting the default table to 15 (i.e. no table is used) and by selecting the default table. Or by programming a 0 for POINT_NUM (ref. to *Calibration Table* at the end of this chapter; function $y=x$) and selecting it. Or by selecting a table with no (zero) points.

A backup of the Gas Tables is generated on Factory Setup. This backup is used for reset the tables.

Soft Start Rate

A change in the set point is performed in a slope, which is defined by SOFT_START_RATE.

Each controller is factory set to its optimum performance.

Start Up the Mass Flow Controller

1. After you have successfully checked all mechanical and electrical connections and when you are certain that there is no gas leakage, then power can be applied to the mass flow controller or to the flow meter respectively.

The first start up should be done preferably using non-critical gas. This could be for example nitrogen or dry air (if there are no reactive residuals in the plumbing system) or any inert gas.

2. Switch on the power supply.

When power is first applied, the output signal jumps to + 4...5 V.

The unit performs automatically a reset, indicated by the red/green blinking status LED. Finally the LED changes to green light which indicates that the electronic circuitry is ready for use.

3. You can monitor the flow output signal as the instruments stabilizes and the output approaches zero. Approximately 15 minutes after power up the signal should be stable within some millivolts close to zero.

Note



Do not use dangerous gases for the first start up. Use a non-critical gas, for example the gas which serves for purging.

Note



If the instrument is being used to control dangerous gases, be sure that the system is fully warmed up before applying gases to the system. You may choose to install a positive shutoff valve to prevent inadvertent gas flow during the warm-up period.

Once the instrument is completely warmed up, you can proceed to zero the unit as required.

Zeroing the Flow Controller

Zero Offset

The Profibus version provides different modes for zero setting. If the mode switch A/B on the inlet side of the unit is set to mode B then parameter USER_ZERO in the PROFIBUS Setup is used. If set to mode A then 5 different options are provided, depending on the configuration of the address switches. Refer to *Zero Modes* in this chapter.

1. If no gas is flowing and the mass flow controller has stabilized (ref. to *Appendix A, Specifications, Warm Up*) the flow output signal should be zeroed by means of the respective command.

Note

Zeroing should be done only on units that are installed in their final position.

2. The command for zero setting also sets the analog flow output signal to zero (pin 2 on the connector ANALOG).

Note

If a pressure difference exists at the mass flow control unit then a small flow might be generated even if the integrated control valve is closed. This is more likely with special units for low inlet pressures . Do not adjust the flow signal then to zero value because it is a real flow but use a positive shutoff valve to definitely stop the flow. Finally with flow completely stopped you should adjust the flow signal to zero.

3. Periodically check the zero adjustment of the unit, e.g. on maintenance intervals. The zero adjustment is affected by thermal effects and especially by contamination.
Beside of the need for measurements of highest accuracy the zero signal is very important for diagnosing the flow sensor and the control valve.

Status LED STS

A two-colour LED, marked STS, between the D-connectors, reports basic status information of the device. It is also used for setup and display of the PROFIBUS address.

LED Status	Meaning
off	No power or a severe fault
green	Ready
green blinking	Communication active
red	Fault condition
red blinking	Communication active but fault condition
green/red blinking	Wink flag was triggered
blinking green/red at power on	Device passes test step of software

Address and Mode Switch A/B

This switch map serves for manually switching from analog mode to Profibus mode and there to select the device's address. In analog mode a mass flow controller needs an analog setpoint signal!

If you are not familiar with the binary code refer to Appendix D how to convert decimal numbers.

Note: After changing any settings the unit must be restarted to store the new configuration.

Switch Assignment

Address Section							Mode	
ADDRESS							B	Top Label
0	0	0	0	0	0	0	Bus	Switch Up Value
1	2	4	8	16	32	64	Analog	Switch Down Value
0	1	2	3	4	5	6	A	Bottom Label

Figure 17: Address and Mode Switch Map A/B

Mode B

If the mode switch sets B mode, the device operates as PROFIBUS device. In that case the address switches define the device PROFIBUS address. If the address switches are all down (127) the internal programmed (via PROFIBUS) address is used. All other address switch settings define the PROFIBUS address by hardware.

Setting an Address

Example for address 5 in Profibus mode:

ADDRESS							B
	■		■	■	■	■	■
■		■					
0	1	2	3	4	5	6	A

Switch position = ■

Mode A

If the mode switch sets A mode, the device operates as an analog device. PROFIBUS may be used for monitoring and the bus address will be used, which was set previously in bus mode. The address switches in analog mode define the analog zeroing mode.

Example for setting analog mode and zero mode 3:

ADDRESS							B
		■	■	■	■	■	
■	■						■
0	1	2	3	4	5	6	A

Switch position = ■

Zero Modes

0	Offset Value is always Zero
1	Offset Value (USER_ZERO) stored in the device is not changed.
2	If the valve is off (VALVE_OVERRIDE == FLOW_OFF) for at least 10 sec. an AUTOZERO is performed.
3	10 sec. after reset, AUTOZERO is performed as long as valve is off. (value stored)
4	10 sec. after reset, AUTOZERO is performed if flow is smaller than 10% of FS. (value stored)

PROFIBUS Protocol

On diagnose data, the PROFIBUS protocol provides 6 bytes of PROFIBUS specific diagnosis information, which comes ahead of the application specific diagnosis data. After this data there is a length byte for the application specific diagnosis data. The total memory requirements are 6 + 1 + 'length of the diagnosis data'.

If the communication of the bus is interrupted a set point from the bus will be set to zero, as soon as the controller has recognized it. In the analog mode, the controller will not react to this event. Of course in any case, all readings from the device are not longer valid, but the PROFIBUS master will mark the device as not available.

Data Interface

The 1179 with PROFIBUS have a small data interface with a basic function set and a full data interface with the full function set of the device. The selection between small and full functionality is made at setup time with the type of configuration data, which is loaded down, to the device.

- Small / Full Parameter selects the internal function set and is declared by the GSD file parameters:

User_Prm_Data_Len and User_Prm_Data. The content of these parameters is either the small setup or full setup structure.

- Small / Full Receive Data, is selected by the MODULE definition in the GSD file. E.g.:

Module = "SMALL_MFC" 0x91, 0xD5, 0xA1, 0xE1 or
Module = "FULL_MFC" 0x91, 0xD7, 0xA1, 0xE1

The data interfaces are documented as data structures with consecutive fields. There is a table entry for each field, with name, address (add), type information and a comment for explanation. The address field (Add.) defines the byte and bit address (**ByteOffset:BitOffset**). For the memory layout the **Motorola Format** is used. The following types are used:

- uint:X an unsigned integer with X bits length.
- long signed long integer (4 bytes)
- uint16 unsigned integer (2 bytes, word)
- uint8 unsigned integer (byte)
- char[X] character array of length X

Send Data

Name: SET_MFC
 Type: Cyclic Write (small & full)
 Size: 6
 Description: Analog Output Transducer Block, Small & Full Setup

Parameters:

Name	Add.	Type	Comment
VALVE_OVERRIDE	1:0	uint:2	NORMAL, FLOW_OFF, PURGE
AUTOZERO	1:2	uint:1	0 to 1 transition activates zeroing if (VALVE_OVERRIDE==FLOW_OFF && FLOW_SETPOINT < 5%FS)
REPORT_DIAG	1:3	uint:3	transition to a new value, triggers the device to send a new actual diagnosis: 0 = no diagnosis 1 = diagnosis of small functionality 2 = diagnosis of full functionality 3 = report selected gas table 4..7 = reserved
WINK_STATUS	1:6	uint:1	0 to 1 transition sets the LED to blink red/green for 3 seconds
ENABLE_TOTALIZER	1:7	uint:1	0 = disabled, 1 = enabled
RESET_TOTALIZER	0:0	uint:1	0 to 1 transition resets totalizer to zero
RESET_STATUS	0:1	uint:1	0 to 1 transition resets error status bits
SELECT_GAS_TABLE	0:2	uint:4	0..14; 15 = default gas table is used
EN_GAS_CORRECTION	0:6	uint:1	0 = disabled, 1 = enabled
Reserved	0:7	uint:1	
FLOW_SETPOINT	2:0	long	in [FLOW_UNIT] in 10E-4 steps valve switched off if setpoint < 1% valve switched on if setpoint > 2%

If the device is in the analog mode (i.e. set point is taken from the analog interface) some functions are not active:

1. VALVE_OVERRIDE is not active
2. EN_GAS_CORRECTION is not active
3. SELECT_GAS_TABLE is not active and the default table will be used

Small Receive Data

Name: FLOW_MFC
 Type: Cyclic Read (small)
 Size: 14
 Description: Analog Input Transducer Block

Parameters:

Name	Add.	Type	Comment
HIGH_LIMIT_ALARM	1:0	uint:1	(flow > HIGH_LIMIT), Hysteresis = 0.5%
LOW_LIMIT_ALARM	1:1	uint:1	(flow < LOW_LIMIT) , Hysteresis = 0.5%
SYSTEM_ERROR	1:2	uint:1	any severe error condition
Reserved	1:3	uint:5	
Reserved	0:0	uint:8	
THERMAL_MASS_FLOW_RATE	2:0	long	in [FLOW_UNIT] in 10E-4 steps
INTERNAL_TEMP	6:0	long	temperature in °C
VALVE_DRIVE_LEVEL	10:0	long	0 .. 100% (in 10E-4 steps) 0% = valve is closed 100% = valve is in purge position (full open)

Full Receive Data

Name: FLOW_MFC
 Type: Cyclic Read (full)
 Size: 18
 Description: Analog Input Transducer Block. This block is used if a full setup was performed.

Parameters:

Name	Add.	Type	Comment
HIGH_LIMIT_ALARM	1:0	uint:1	(flow > HIGH_LIMIT), Hysteresis = 0.5% *
LOW_LIMIT_ALARM	1:1	uint:1	(flow < LOW_LIMIT) , Hysteresis = 0.5% *
SYSTEM_ERROR	1:2	uint:1	any severe system error condition
HIGH2_LIMIT_ALARM	1:3	uint:1	(flow > HIGH2_LIMIT), Hysteresis = 0.25%
LOW2_LIMIT_ALARM	1:4	uint:1	(flow < LOW2_LIMIT), Hysteresis = 0.25%
VALVE_CLOSED	1:5	uint:1	(THERMAL_MASS_FLOW_RATE < 1%) && (VALVE_OVERRIDE == FLOW_OFF)
PURGE	1:6	uint:1	THERMAL_MASS_FLOW_RATE > 110%
OVER_TEMPERATURE	1:7	uint:1	INTERNAL_TEMP > MAX_TEMP
VALVE_DRIVE_ALARM	0:0	uint:1	VALVE_DRIVE_LEVEL > MAX_VTP
CALIBRATION_RECOMMENED	0:1	uint:1	TIME_TO_CAL count down expired
UNCALIBRATED	0:2	uint:1	if a disabled or no table is used
CONTROLLER_ERROR	0:3	uint:1	abs (setp - flow) greater for a longer time period
MEMORY_FAILURE	0:4	uint:1	E2PROM checksum error
UNEXPECTED_CONDITION	0:5	uint:1	any process error condition
Reserved	0:6	uint:2	
THERMAL_MASS_FLOW_RATE	2:0	long	in [FLOW_UNIT] in 10E-4 steps
INTERNAL_TEMP	6:0	long	temperature in ° C
VALVE_DRIVE_LEVEL	10:0	long	0 .. 100% (in 10E-4 steps) 0% = valve is closed 100% = valve is in purge position (full open)
FLOW_TOTALIZED	14:0	long	in sl / sm3 (in 10E-4 steps) i.e. min. 298 days for a 500 range.

*) Hysteresis is +/- 0.25% (i.e. 0.5% in total) based on actual limit

Small Setup

Name: SMALL_SETUP
 Type: Initial Write (small)
 Size: 19

Parameters:

Name	Add.	Type	Comment
STRUCT_ID	0:0	uint8	0x10 (SMALL_SETUP)
INITIAL_SETUP	2:0	uint:1	THIS, ROM
BASE_UNIT	2:1	uint:1	Display in base unit
OPERATION_MODE	2:2	uint:1	0=ANALOG, 1=PROFIBUS
Reserved	2:3	uint:5	
Reserved	1:0	uint:8	
USER_SPAN	3:0	long	5% .. 200% in [%] (in 1E-4 steps)
USER_ZERO	7:0	long	-5% .. +5% of full scale (in 1E-4 steps)
HIGH_TRIP_POINT	11:0	long	-10% .. +120% of full scale (in 1E-4 steps)
LOW_TRIP_POINT	15:0	long	-10% .. +120% of full scale (in 1E-4 steps)

Full Setup

Name: FULL_SETUP
 Type: Initial Write (full)
 Size: 80

Parameters:

Name	Add.	Type	Comment
STRUCT_ID	0:0	uint8	0x11 (FULL_SETUP)
INITIAL_SETUP	2:0	uint:1	THIS, ROM
BASE_UNIT	2:1	uint:1	display in base unit
OPERATION_MODE	2:2	uint:1	0=ANALOG, 1=PROFIBUS
SET_USER_SPAN	2:3	uint:1	1=USER_SPAN will be updated
SET_USER_ZERO	2:4	uint:1	1=USER_ZERO will be updated
SET_HIGH_TRIP_POINT	2:5	uint:1	1=HIGH_TRIP_POINT will be updated
SET_LOW_TRIP_POINT	2:6	uint:1	1=LOW_TRIP_POINT will be updated
SET_GAS_CORRECTION	1:7	uint:1	1=GAS_CORRECTION will be updated
SET_DEFAULT_TABLE	1:0	uint:1	1=DEFAULT_TABLE will be updated
SET_HIGH2_TRIP_POINT	1:1	uint:1	1=HIGH2_TRIP_POINT will be updated
SET_LOW2_TRIP_POINT	1:2	uint:1	1=LOW2_TRIP_POINT will be updated
SET_FILTER_SETTLING	1:3	uint:1	1=FILTER_SETTLING will be updated
SET_SOFT_START_RATE	1:4	uint:1	1=SOFT_START_RATE will be updated
SET_TIME_TO_CAL	1:5	uint:1	1=TIME_TO_CAL will be updated
SET_CAL_DATE	1:6	uint:1	1=CAL_DATE will be updated
SET_USER_TAG	1:7	uint:1	1=USER_TAG will be updated
USER_SPAN	3:0	long	5% .. 200% in [%] (in 1E-4 steps)
USER_ZERO	7:0	long	-5% .. +5% full scale (1E-4 steps)
HIGH_TRIP_POINT	11:0	long	-10% .. +120% full scale (1E-4 steps)
LOW_TRIP_POINT	15:0	long	-10% .. +120% full scale (1E-4 steps)
GAS_CORRECTION	19:0	long	0.05 .. 2.00 (in 1E-4 steps)

(continued on next page)

Name	Add.	Type	Comment
DEFAULT_TABLE	23:0	uint8:4	0 .. 14 is the default table, 15 function (y=x) is the gas table
Reserved	23:4	uint8:4	
HIGH2_TRIP_POINT	24:0	long	-10% .. +120% full scale (1E-4 steps)
LOW2_TRIP_POINT	28:0	long	-10% .. +120% full scale (1E-4 steps)
FILTER_SETTLING	32:0	long	0.0 .. 1000.0 in [sec] (in 1E-4 steps)
SOFT_START_RATE	36:0	long	0.0 .. 3600.0 in [sec] (in 1E-4 steps)
TIME_TO_CAL	40:0	uint16	if SET_TIME_TO_CAL is 1 it will last TIME_TO_CAL hours until CALIBRATION_RECOMMENDED flag becomes active.
CAL_DATE	42:0	char[6]	MM/DD/YY
USER_TAG	48:0	chr[32]	any 32 character string

Small Diagnostics

Name: SMALL_DIAG
 Type: Diagnose (small)
 Size: 22

Parameters:

Name	Add.	Type	Comment
STRUCT_ID	0:0	uint8	0x20 (SMALL_DIAG)
Exception Status			
ALARM_DEVICE_COMMON	1:0	uint:1	specific to network (e.g. power fail)
ALARM_DEVICE_SPECIFIC	1:1	uint:1	specific to flow device (e.g. r/w EPROM)
ALARM_MKS_SPECIFIC	1:2	uint:1	specific to MKS
ALARM_TABLE_ERROR	1:3	uint:1	Reports cal. Table errors
Reserved	1:4	uint:4	
Identification:			
PRODUCT_CODE	2:0	uint16	1179
REVISION_CODE	4:0	uint8	A
VERSION_CODE	5:0	uint16	0x0100
Specification:			
FULL_SCALE_RNG	7:0	long	full scale range in [FLOW_UNIT] (in 1E-4 steps)
FLOW_UNIT	11:0	uint8	SCCM, SLM (SCCM is base unit)
Status:			
INTERNAL_TEMP	12:0	long	temperature in °C
VALVE_DRIVE_LEVEL	16:0	long	0 .. 100% (in 10E-4 steps)
RUN_HOURS	20:0	uint16	hours

Full Diagnostics

Name: FULL_DIAG
 Type: Diagnose (full)
 Size: 217

Parameters:

Name	Add.	Type	Comment
STRUCT_ID	0:0	uint8	0x21 (SMALL_DIAG)
ALARM_DEVICE_COMMON	1:0	uint:1	specific to network (e.g. power fail)
ALARM_DEVICE_SPECIFIC	1:1	uint:1	specific to flow device (e.g. r/w EPROM)
ALARM_MKS_SPECIFIC	1:2	uint:1	specific to MKS (LinTab error)
ALARM_TABLE_ERROR	1:3	uint:1	Reports cal. Table errors
Reserved	1:4	uint:4	
PRODUCT_CODE	2:0	uint16	1179
REVISION_CODE	4:0	uint8	A
VERSION_CODE	5:0	uint16	0x0100
FULL_SCALE_RNG	7:0	long	full scale range in [FLOW_UNIT] (in 1E-4 steps)
FLOW_UNIT	11:0	uint8	SCCM, SLM
INTERNAL_TEMP	12:0	long	temperature in °C
VALVE_DRIVE_LEVEL	16:0	long	0 .. 100% (in 10E-4 steps)
RUN_HOURS	20:0	uint16	hours
MANUFACTURER	22:0	char[20]	MKS INSTRUMENTS
MODEL_DESIGNATION	42:0	char[20]	1179AX12CGA4V
SERIAL_NUMBER	62:0	char[20]	999999 G
DEVICE_TYPE	82:0	char[6]	MFC, MFM
MODEL_TYPE	88:0	char[6]	1179
FIRMWARE_REVISION	94:0	char[6]	1.01
HARDWARE_REVISION	100:0	char[6]	A
FACTORY_CAL_DATE	106:0	char[6]	MM/DD/YY
VENDOR_CODE	112:0	uint16	0

(continued on next page)

Name	Add.	Type	Comment
STANDARD_TEMP	114:0	long	273.0 K (0 °C)
STANDARD_PRESSURE	118:0	long	101.1kPa (in 10E-4 steps)
VALVE_TYPE	122:0	uint8	0=SOLENOID, 1=VOICE_COIL, 2=PIEZO_ELECTRIC
VALVE_POWER_OFF_MODE	123:0	uint8	0=CLOSED, 1=OPEN, 2=LAST_POS
GAS_TABLE_NUM	124:0	uint8	Number of gas tables programmed. i.e. values != 0 in GAS_CODE_OF_TABLE_I
GAS_CODE_OF_TABLE_I	125:0	uint8[15]	gas code of gas tables 0=no table (y=x)
POINT_NUM_OF_TABLE_I	140:0	uint8[15]	Point number of gas tables
TABLE_FLAGS	155:0	uint:1[15]	0=FACTORY; 1=USER; 1 means that the user has overwritten the gas table once. All these flags will be reset at factory setup.
ACTIVE_GAS_NAME	157:0	char[16]	e.g. N2, is name of DEFAULT_TABLE if there was no cyclic comm. In the past.
CAL_DATE	173:0	char[6]	MM/DD/YY
USER_TAG	179:0	char[32]	any 32 character string
REM_TIME_TO_CAL	211:0	uint16	Remaining TIME_TO_CAL
FLOW_TOTALIZED	213:0	long	in sl/sm3 (in 10E-4 steps) i.e. min. 298 days for a 500 range. No base unit feature.

Calibration Table

Name: CAL_TABLE
 Type: Initial Write, Diagnosis (full)
 Size: 140

Parameters:

Name	Add.	Type	Comment
STRUCT_ID	0:0	uint8	0x12 or 0x22 for diagnosis
GAS_TABLE_IDX	1:0	uint8	0..14
GAS_CODE	2:0	uint8	0..254 255 resets to factory setup
POINT_NUM	3:0	uint8	2..15 = table with 2 .. 15 points 0 = disables table 1 = enables table
GAS_NAME	4:0	char[16]	e.g. N2
SENSOR_VALS	20:0	long[15]	in [FLOW_UNIT] in 10E-4 steps
FLOW_VALS	80:0	long[15]	in [FLOW_UNIT] in 10E-4 steps

If a table is loaded, which is not strict monotonous, the table will be disabled (POINT_NUM = 0). If a table, with a not valid index, is loaded, no tables will be affected. In both case the error flag for the table will be set.

The calibration tables convert the measured value (SENSOR_VALS) to the true physical value (FLOW_VALS). If the actual measured value is between two SENSOR_VALS, the flow will be calculated by linear interpolation. If the measured value is outside of the table definitions, the first (last) straight line will be continued.

The GAS_CODE may be any definition for gases. It is not evaluated. The GAS_NAME may be any 16 character string. It is also not evaluated.

The calibration tables stored from the factory may be recalled by an GAS_CODE of 255. In this case the TABLE_FLAG in the full diagnostic is reset.

PROFIBUS Setup

GSD Files Usage

A GSD File describes the device and defines the configuration (Parameter) for the actual application. The 1179PB may have different configurations: Small Setup, Full Setup and Calibration table. The Standard GSD file uses a default parameter set in the Small Setup structure. Others may be defined.

The 1179PB is a device, which normally would be looked at, as one module. This is also the definition in the standard GSD File. But it could be an advantage, to look at it as a device, which consists of 4 modules, one for each data block type (digital input, analog input, digital output, analog output). See the section of a GSD file with 4 module below.

Note:

At the time of release of this instruction manual the standard GSD file was **mks 1179.gsd** (June 2002)

Standard GSD File

```

; Slave GSD File for MKS flow controller
;=====
#Profibus_DP
Vendor_Name           = "MKS"
Model_Name            = "MKS1179B00"
Revision              = "V1.0"
Ident_Number          = 0x1179
Protocol_Ident        = 0                ; PROFIBUS DP
Station_Type          = 0                ; DP Slave
FMS_supp              = 0                ; FMS is not supported
Hardware_Release      = "V12"
Software_Release      = "V010906"
;>>> supported Baudrate
9.6_supp              = 1
19.2_supp              = 1
93.75_supp             = 1
187.5_supp             = 1
500_supp               = 1
1.5M_supp              = 1
3M_supp                = 1
6M_supp                = 1
12M_supp               = 1
;>>> Default TSDR
MaxTsd_r_9.6           = 60
MaxTsd_r_19.2          = 60
MaxTsd_r_93.75         = 60
MaxTsd_r_187.5         = 60
MaxTsd_r_500           = 100
MaxTsd_r_1.5M          = 150
MaxTsd_r_3M            = 250
MaxTsd_r_6M            = 450
MaxTsd_r_12M           = 800
Redundancy              = 0                ; no system Redundancy
Repeater_Ctrl_Sig      = 2                ; TTL level
24V_Pins                = 0                ; not connected
;>>> Slave Parameter
Freeze_Mode_supp       = 1                ; Freeze Mode supported
Sync_Mode_supp         = 1                ; Sync Mode supported
Auto_Baud_supp         = 1                ; automatic Baudrate Search supported
Set_Slave_Add_supp     = 1                ; SetSlaveAdr supported
User_Prm_Data_Len      = 19
User_Prm_Data           = 0x10,0x00,0x04,0x00,0x0f,0x42,0x40,0x00,0x00,0x00,\
                        0x00,0x00,0x0d,0xbb,0xa0,0x00,0x01,0x86,0xa0
                        ; float data format signed integer
Min_Slave_Intervall    = 1                ; in 100 ys
Modular_Station        = 0                ; it is no modular Station
;>>> Device diagnostic
Unit_Diag_Bit(0)       = "ALARM_DEVICE_COMMON"
Unit_Diag_Bit(1)       = "ALARM_DEVICE_SPECIFIC"
Unit_Diag_Bit(2)       = "ALARM_MKS_SPECIFIC"
Module = "SMALL_MFC" 0x91, 0xD5, 0xA1, 0xE1 ; small send / receive
EndModule

```

Chapter 7: Theory of Operation

Technique of Measurement and Control, Electronics

The design of the 1179B flow controller incorporates an advanced flow sensor, a new control valve and an optimized bypass. The latest generation two-element sensing circuit provides accurate, repeatable performance even in low flow ranges (< 10 sccm). Low temperature effect from ambient temperature change and a low attitude sensitivity effect are also ensured. The newly optimized sensor/bypass arrangement minimizes the flow splitting error for gases with different densities, which dramatically improves measurement accuracy when gases other than the calibration gas are used.

The surface mount digital, processor controlled electronic circuitry allows optimum adjustment of the sensing and signal conditioning circuitry and provides tuned flow control for fast response to any set point in common with excellent stability.

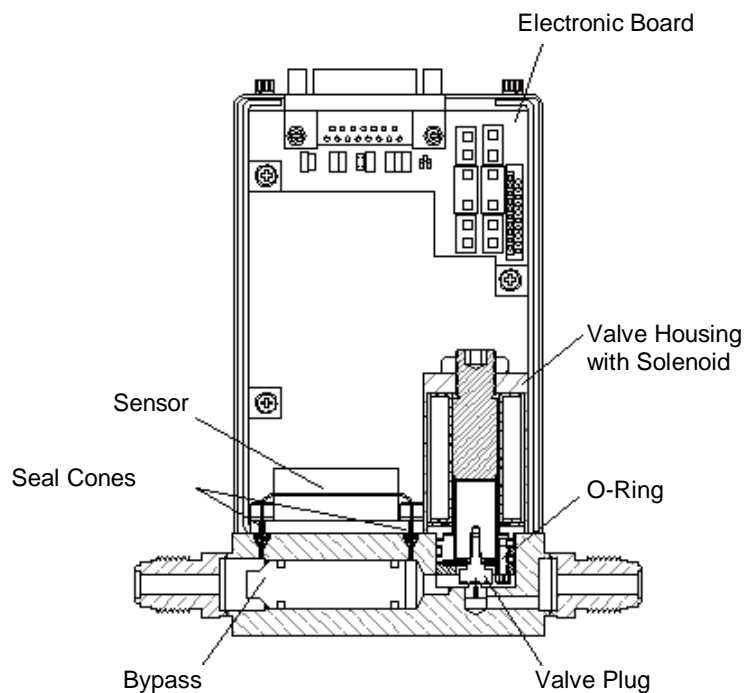

Figure 18: Assembly

The flow controller type 1179B measures and controls the gas flow rate accordingly to a given setpoint signal, which may be an analog signal or a digital command when using the Profibus version. The control range is from 2 % to 100% of full scale. The accuracy of the flow measurement is $\pm (0,5 \% \text{ of reading} + 0,2 \% \text{ of F.S.})$ for both the analog units and Profibus versions.

Flow Path

Upon entering the flow controller, the gas stream passes first through the metering section of the instrument for its mass flow to be measured. The gas moves on through the control valve for its rate of flow to be regulated according to the given set point, and then exits the instrument at the established rate of flow.

The metering section consists of one of the following:

- A sensor tube for ranges ≤ 10 sccm (N_2 equivalent)
- A sensor tube and parallel bypass for ranges > 10 sccm (N_2 equivalent)

The geometry of the sensor tube, in conjunction with the specified full scale flow rate, ensures fully developed laminar flow in the sensing region. The bypass elements, in those instruments containing them, are specifically matched to the characteristics of the sensor tube to achieve a laminar flow splitting ratio which remains constant throughout each range.

Measurement Technique

The flow measurement is based on differential heat transfer between temperature sensing heater elements which are attached symmetrically to the sensor tube. This senses the thermal mass movement which is converted to mass flow via the specific heat, C_p , of the gas. The resulting signal is then amplified, digitalized and linearized. The corrected digital signal is then transferred to the control section (controllers only) and also converted into a 0 – 5 V analog signal. Analog versions of the units described herein provide just the analog flow signal, Profibus versions provide both the digital information and the analog signal. The measurement principle of keeping temperatures constant results in much shorter response time than conventional principles.

Control Circuitry

In the digital control section the flow rate is compared to the setpoint value and a control signal (digital) is generated.

The digital control signal is then conditioned by a PID-algorithm, optimized for fastest controlling and finally fed into the control circuitry which steers the solenoid control valve. The digital control reduces overshoots to a minimum and for completely regulating the flow until the difference from the setpoint is zero. Typical settle time is 0,8 s, for faster tuning contact MKS.

The control valve is closed when no power is applied (Normally Closed, N.O.). Controlling flow is done by levitating the valve plug from the valve orifice. The plug is mounted at the front end of the solenoid armature.

Control Valve

The control valve is a specially designed solenoid driven valve. The armature is suspended by two radial springs. This design provides frictionless movement and thus precise control. Mounted at the front end of the cylindrical armature is the valve plug which incorporates the seal disc of Viton or Kel-F or Teflon (ref. to *Appendix A, Specifications*). By preload force of the two above mentioned springs the seal disc is pressed against the valve orifice, closing it's flow channel. Therefore the valve is closed when not activated. It is a „Normally Closed“ (N.C.) valve.

The inside diameter of the orifice determines the conductance. Each flow controller incorporates a valve orifice with a conductance in accordance to the full scale range. The valve orifice in standard units is sized that with a pressure difference between inlet and outlet fitting of typical 0,7 bar to 2,75 bar the specified full scale flow rate will be achieved. (related to air or nitrogen). For more information refer to *Appendix A, Specifications*.

For special applications with low pressure conditions, e.g. vaporizer sources, configurations can be provided. In this case the valve will have an orifice with higher conductance (=larger diameter of the flow channel). Mass flow controllers for applications where only 200 mbar (or less) are available have been realized.

At high line pressures in combination with high flow rates it may be necessary to have an orifice with smaller conductance installed.

The mass flow monitor 179B has no valve!

This page intentionally left blank

Chapter 8: Gas Correction Factor (GCF)

The Gas Correction Factor (GCF):

A Gas Correction Factor (GCF) is used to indicate the ratio of flow rates of different gases which will produce the same output signal from a mass flow meter / controller. The GCF is a function of specific heat, density, and the molecular structure of the gases. Nitrogen (N₂) is normally used as the baseline gas (GCF = 1) since flow meters and controllers are usually calibrated with nitrogen.

$$\text{GCF (N}_2\text{)} = 1$$

Appendix C lists the gas correction factors for many commonly used pure gases. If the gas you are using is not listed in there, you must calculate its GCF. The equations for calculating gas correction factors are described below.

How To Calculate the GCF for Pure Gases

To calculate the Gas Correction Factor for any pure gas (X), use the following equation:

$$\text{GCF}_x = \frac{0,3106 * s}{\rho_x * \text{cp}_x}$$

where:

GCF_x	= gas correction factor for gas X
0,3106	= (standard density of nitrogen) • (specific heat of nitrogen)
s	= molecular structure correction factor where S equals:
1.030	for monoatomic gases
1.000	for diatomic gases
0.941	for triatomic gases
0.880	for polyatomic gases
d_x	= standard density of gas X, in g/l (at 0° C and 1013,25 mbar)
cp_x	= specific heat of gas X, in cal/g° C

How To Calculate the GCF for Gas Mixtures

For gas mixtures, the calculated Gas Correction Factor is not simply the weighted average of each component's GCF. Instead, the GCF (relative to nitrogen) is calculated by the following equation:

$$\text{GCF}_x = \frac{0,3106 * (a_1s_1 + a_2s_2 + \dots a_ns_n)}{a_1\rho_1cp_1 + a_2\rho_2cp_2 + \dots a_n\rho_ncp_n}$$

where:

GCF_m	= gas correction factor for a gas mixture								
0.3106	= (standard density of nitrogen) (specific heat of nitrogen)								
$a_1, a_2, \dots a_n$	= fractional flow of gases 1 through n <i>Note:</i> a_1 through a_n must add up to 1.0								
$s_1, s_2, \dots s_n$	= Molecular Structure correction factor for gases 1 through n where S equals: <table style="margin-left: 20px;"> <tr> <td>1.030</td> <td>for monatomic gases</td> </tr> <tr> <td>1.000</td> <td>for diatomic gases</td> </tr> <tr> <td>0.941</td> <td>for triatomic gases</td> </tr> <tr> <td>0.880</td> <td>for polyatomic gases</td> </tr> </table>	1.030	for monatomic gases	1.000	for diatomic gases	0.941	for triatomic gases	0.880	for polyatomic gases
1.030	for monatomic gases								
1.000	for diatomic gases								
0.941	for triatomic gases								
0.880	for polyatomic gases								
d_1 through d_n	= standard density for gases 1 through n, in g/l (at 0° C and 760 mmHg)								
cp_1 through cp_n	= specific heat of gases 1 through n, in cal/g° C								

Note



1. When using the GCF, the accuracy of the flow reading may vary by $\pm 5\%$, however, the repeatability will remain $\pm 0,2\%$ of FS.
2. The linearity and accuracy may be improved by calibrating the unit with the process gas or using a gas with equivalent properties (surrogate gas). Contact MKS for more information.
3. All MKS readouts have gas correction adjustment controls to provide direct readout.

Example

Calculate the GCF for a gas mixture of argon (gas 1) flowing at 150 sccm and nitrogen (gas 2) flowing at 50 sccm, where:

Argon (Ar)	Nitrogen (N₂)
$a_1 = \frac{150}{200} = 0.75$	$a_2 = \frac{50}{200} = 0.25$
$s_1 = 1.030$	$s_2 = 1.000$
$d_1 = 1.782 \text{ g/l}$	$d_2 = 1.250 \text{ g/l}$
$cp_1 = 0.1244 \text{ cal/g } ^\circ\text{C}$	$cp_2 = 0.2485 \text{ cal/g } ^\circ\text{C}$

$$\begin{aligned}
 GCF_M &= \frac{(0.3106) [(0.75)(1.030) + (0.25)(1.000)]}{(0.75)(1.782)(0.1244) + (0.25)(1.250)(0.2485)} \\
 &= \frac{(0.3106) [(0.7725) + (0.25)]}{(0.1663) + (0.0777)} \\
 &= \frac{(0.3106) (1.0225)}{0.244} \\
 &= \frac{0.3176}{0.244} \\
 GCF_M &= 1.302
 \end{aligned}$$

Mass Flow Rate at a Different Reference Temperature

The equations for calculating the GCF assume that the MFC was calibrated at a reference temperature of 0° C (~273,15 K). If you want to read the mass flow as if the MFC was calibrated at a different reference temperature, adjust the calculated GCF value using the following equation:

$$GCF_x = GCF \times \frac{T_x}{T_N}$$

where:

T_x = actual reference temperature in Kelvin K

T_N = international standard temperature 273.15 K (= 0° C)

Direct Reading of the Analog Output Signal

If a direct reading of output is desirable, and the readout equipment has no GCF potentiometer, a proper input divider may be constructed.

Example: Using a mass flow controller, full scale range 500 sccm N_2 , full scale signal is 5 VDC and a process gas CCl_4 . A flow rate of 100 sccm CCl_4 shall be converted into 1 VDC. As the gas correction factor of CCl_4 is 0,31 the flow signal must be divided 3.22 to 1.00 volts.

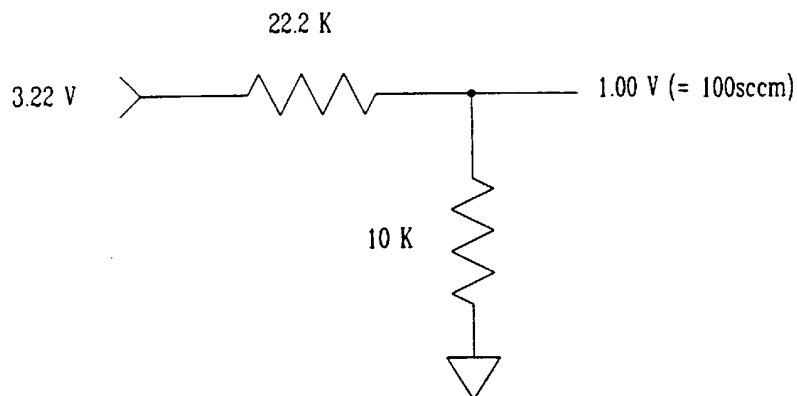

Figure 19: Voltage Divider

Note



All MKS readouts have gas correction adjustment controls to provide direct readout. The analog setpoint output signal is generated accordingly.

Chapter 9: MFC Sizing Guidelines

General

To select the correct MFC for an application, you must determine the:

- flow controller range
- appropriate valve configuration

The flow controller range depends on the desired flow rate and the gas correction factor for the gas to be used. MKS states the flow controller ranges based on flow rate of nitrogen; the flow rate for other gases may vary.

The proper valve configuration depends upon the flow range, inlet pressure, differential pressure across the unit, and density of the gas. Proper valve configurations have been established for all standard flow ranges flowing nitrogen under standard operating pressures. These configurations are suitable for virtually all gases and pressure conditions.

Determining the Flow Controller Range

The Type 1179 controller is available in ranges of 10, 20, 50, 100, 200, 500, 1000, 2000, 5000, 10000 and 20000 sccm (N₂ equivalent). To select the appropriate range, you must determine the flow rate of nitrogen that is equivalent to the flow rate of the desired gas. Calculate the ratio of the GCF of nitrogen (1.00) to the GCF of the desired gas (refer to *Appendix C* as shown in the following example).

Example:

You need a flow rate of 250 sccm of argon (Ar). What range flow controller should you use?

1. Find the Gas Correction Factor of Ar.

The GCF for Ar is 1.39.

2. Insert the GCF of Ar in the following formula:

$$(x) = (\text{Argon flow rate}) \times \text{GCF (N}_2) : \text{GCF (Ar)}$$

where x is the equivalent flow rate of nitrogen (sccm).

$$\frac{(1.00)}{(1.39)} = \frac{(x)}{(250 \text{ sccm Ar})}$$

$$(x) = 180 \text{ sccm N}_2$$

A flow rate of 250 sccm of argon will produce a flow rate equivalent to 180 sccm of N₂. This falls within the range of a 200 sccm flow controller.

When calculating equivalent N₂ flows using gas correction factors, be sure to use a flow controller with a sufficient flow rate range. For example, if the calculated equivalent N₂ flow in the example shown above is 205 sccm, use a 500 sccm flow controller. The 500 sccm instrument can then be calibrated such that 205 sccm N₂ = full scale.

Note



When using a gas with a density higher than nitrogen, be sure that the control valve full scale range can accommodate the desired flow rate. Please call the MKS Applications group if you have any questions.

Configurations for Low or High Differential Pressure

The mass flow controllers are designed to operate under certain differential pressure conditions. Nominal values are listed in *Appendix A, Specifications*.

On request however, it is possible to provide special configurations for many applications with low or high pressure drops, respectively. A typical low pressure application for example is a vaporizer where liquid material is evaporated at low pressure and reasonable low temperature.

Chapter 10: Maintenance

General

After proper installation and correct setup there is typically only the need for occasionally checking and - if necessary - readjusting the zero flow signal. In general no further maintenance is required. How often the calibration and the valve should be checked depends on physical influences, e.g. temperature, vibrations, dust etc., is also related to the required accuracy and last not least on how the process gas affects the wetted parts inside the unit.

If a controller fails to operate properly upon receipt, check for shipping damage, and check the power/signal cable for correct continuity. Any damage should be reported to the carrier and MKS Instruments immediately.

Zero Adjustment

To achieve optimum accuracy and reliability you should periodically check the zero readout and - if necessary - readjusting it. For adjusting zero refer to the instructions in *Chapter 5; Chapter 6, Operation of Analog/Profibus Units*. How often the zero readout should be checked and corrected depends on the required accuracy and reproducibility the process is asking for.

Checks and Recalibration

Checks and recalibrations can be done by any service center of MKS (refer to section *Repair*). If nothing else is specified or shorter intervals are necessary we recommend annual maintenance and recalibration at a service center of MKS.

MKS offers many standard equipment for checking and calibrating mass flow meters / controllers to allow you making all testing and calibration even in situ.

For electronic testing and trouble shooting we recommend to do all measurements directly at the interface connector of the unit. This eliminates or detects erratic diagnosis, typically generated by incorrect grounding. MKS offers for this purpose so called breakout connectors. These are switched between the connector of the unit and the cable and provide a test pin for each wire, thus allowing direct access for a volt meter or oscilloscope etc.

Profibus Support Kit

This kit allows convenient setup and diagnosis of a Profibus mass flow meter/controller. It can be ordered from MKS as Profibus Support Kit, part no. 1179-PB-SUPPORT, consisting of

- 1 Disc 3,5"
- 1 RS 232 cable
- 1 Converter RS232/RS485
- 1 Instruction paper

Customer Support

Standard maintenance and repair services are available at all of our regional MKS Calibration and Service Centers, listed at the end of this manual. In addition, MKS accepts the instruments of other manufacturers for recalibration using the Primary and Transfer Standard calibration equipment located at all of our regional service centers. Should any difficulties arise in the use of your type 1179 instrument, or to obtain information about companion products MKS offers, contact any authorized MKS Calibration and Service Center. If it is necessary to return the instrument to MKS, the MKS Calibration and Service Center will inform you about any formal requirements.

You will find a list of MKS Calibration and Service Centers and a form for Declaration of Contamination at the end of this handbook.

Warning



All returns to MKS Instruments must be free of harmful, corrosive, radioactive, or toxic materials.

Troubleshooting

Symptoms	Possible Cause	Remedy
No output or overrange at zero (after warm-up)	Improper cable Valve override function applied (Mass flow controller) Electronics malfunctioning	Check cable for type Disconnect / disable valve override Return for service
Unit indicates a negative flow	Unit installed in gas stream backwards	Reinstall unit in proper flow direction
Controller does not track set point.	Improper zero adjustment Improper grounding(s)	Zero meter output Check all ground connections. Check signals, if possible directly at the unit's connector
Controller does not function	Electronics malfunctioning Valve sticking, clogged, contaminated, corroded. Shutoff valve upstream or downstream closed No inlet pressure	Return for service Check compatibility of the process gas with materials wetted (corrosion is typically also visible inside the process fittings) Readjust the valve (return for service) Open shutoff valve first, then apply again setpoint to the unit. Regulate inlet pressure
Oscillation	Supply pressure unstable, e.g. defective pressure regulator. Supply pressure too high	Check manufacturers' specifications Reduce upstream pressure

(continued next page)

Symptoms	Possible Cause	Remedy
Excessive closed conductance	Inadequate valve preload Valve seat elastomer damaged	Readjust the valve (return for service) Check compatibility of process gas with seat material Replace or change valve seat elastomer (return for service)
Unit does not achieve full flow	Upstream pressure too low Excessive valve preload Valve seat disc damaged, e.g. swollen	Increase upstream pressure Readjust the valve Check compatibility of process gas with seat material Replace or change valve seat elastomer (return for service)

Table 3: Troubleshooting

Chapter 11: Type 179B, 1179B, 1479B, 2179B (Comparison)

Type 179B

The type 179B is the standard mass flow meter and provides the base for the mass flow controllers type 1179, 1479 and 2179. The imprint on the aluminium housing is MASS-FLO METER. The flow path is completely metal sealed. Therefore the meter is inherently an all metal sealed unit.

Type 1179B

The Type 1179B is the standard version of the MKS Mass-Flo[®] Controller series. Compared to the flow monitor type 179B it employs an integrated control valve, solenoid driven, and a digital control electronics. There is just one O-ring seal in the valve body, all other process gas wetted surfaces are metal sealed or even welded.

The control valve is normally closed, e.g. when no power or a zero setpoint signal is applied. The sealing material of the valve plug is typically Viton, Kel-F or Teflon which provides a closed conductance which is sufficiently small for many application. Nevertheless it must be pointed out that for reliable and completely closing a positive shut off valve is strongly recommended.

Type 1479B

The Type 1479B is the completely metal sealed type 1179B, meaning that also the one O-ring seal is replaced by a metal C-seal. The valve plug seal disc is Kel-F or Teflon, depending of the range.

Type 2179B

The Type 2179B consists of a mass flow controller 1179B with a positive shut off valve closely welded to the outlet. This is the recommended configuration for closing flow at minimum leak rate with minimized dead volume between shutoff valve and control valve. The welded connection prevents an additional connection by fittings with potential leak.

The shutoff valve is an all metal sealed diaphragm valve (material: 316L VAR SST and Elgiloy) with a PCTFE valve seat.

The complete stick is mounted on a common base plate.

Pneumatic Positive Shutoff Valve

To open the shutoff valve pressurized air at 4,1 bar(g) to 8,2 bar(g) is required. The air port is a 1/8" – 27 NPT female thread. To close the valve the air pressure must be released.

The thread connection should be done using Teflon tape thus reducing friction and avoiding damages to the thread.

Note



Throughout this handbook all three types of mass flow controllers, namely 1179B, 1479B and 2179B will be expressed by type 1179B in common. The types 1479B and 2179B will only be mentioned by their specific name where it is necessary to avoid confusion.

Appendix A: Product Specifications

Specifications

Accuracy ¹	
Analog and Profibus version:	0,5 % of reading plus 0,2 % of full scale
Control Range (MFC only)	2,0 % to 100% of full scale
Controller Settling Time ²	typically < 0,8 seconds (to within 2 % of set point); faster settling time on request
Full Scale Ranges (nitrogen equivalent) ³	10, 20, 50, 100, 200, 500, 1000, 2000, 5000, 10.000, 20.000 sccm
Maximum Inlet Pressure	150 psig
Operational Differential Pressure (MFC only) ⁴	
≤ 5000 sccm	0,7 bar (g) to 2,8 bar (g)
10.000 to 20.000 sccm	1 bar (g) to 2,8 bar (g)
Pressure Coefficient	0.02 % of reading/psi
Repeatability (MFC only)	± 0,2 % of full scale
Resolution (measurement)	0,1 % of full scale
Temperature Coefficients	
Zero	<0.04 % of full scale /°C (400 ppm)
Span	<0,08 % of reading /°C (800 ppm)
Warm Up Time	15 minutes

¹ Includes non-linearity, hysteresis and non-repeatability.

² Controller settling time per SEMI E17-91, specified for flows starting from 0 to 10% (or greater) of full scale.

³ sccm = std. cm³ / min ; standard (std.) condition: 1013,25 mbar and 0 °C.

⁴ Referenced to an MFC outlet pressure at atmosphere.

Environmental Specifications

Storage Humidity Range	0 to 95% relative humidity, non-condensing
Operating Temperature	0° to 50° C (32° to 122° F)
Storage Temperature	-20° to 50° C (-4° to 122° F)

Electrical Specifications

Connectors	
Analog Version:	Sub D 15-poles, pin
Profibus Version:	Sub D 9-poles, pin (Analog Interface) Sub D 9-poles, socket (Profibus Interface)
Input Voltage/Current Required	20,5 to 31,5 VDC ²
Maximum at Start Up (first 5 seconds) ⁵	@ 200 mA
Typical at Steady State	@ 100 mA
Output Impedance	< 1 Ω
Output Signal/Minimum Load	0 to + 5 VDC into > 10 kΩ
Set Point Command Signal (not for type 179B)	0 to + 5 VDC from < 20 kΩ

⁵ Add 100 mA to start up current if the valve is energized.

² For the use of the Profibus version in analog mode is a +/- 15 VDC power supply required. For the use in digital mode a +/- 15 VDC or a 24 VDC power supply is sufficient.

Physical Specifications

Dimensions	refer to Chapter 4
Fittings: Standard Optional	Cajon® 4-VCR® male compatible Cajon® 4-VCO® male compatible 6 mm Swagelok compatible 1/4" Swagelok compatible DN 16 KF
Internal Surface Area (500 sccm unit)	49,7 cm ² (7,7 in ²)
Internal Volume (500 sccm unit)	4,43 cm ³ (0,27 in ³)
Leak Integrity (mbar·l/s He) External Through closed Valve (MFC only) Type 2179B External Through closed Shutoff Valve	< 1 x 10 ⁻⁹ < 1 x 10 ⁻⁴ (≤ 1 % of full scale for units with ranges greater 10.000 sccm; test gas N ₂ at 2,7 bar (g) at inlet and atmosphere at outlet) < 1 x 10 ⁻⁹ < 4 x 10 ⁻⁹
<u>Materials Wetted</u> Mass Flow Controller: Body Valve Standard Sealing Material Optional Mass Flow Meter:	316L SST Nickel, Elgiloy, Kel-F® (when Kalrez sealed and range ≤200 sccm) or Teflon (when Kalrez sealed and range ≥500 sccm) Viton® Buna-N, Neoprene®, Kalrez® 316L SST
Mass	≤ 0,9 kg (1,9 lbs)

Due to continuing research and development activities, these product specifications are subject to change without notice.

This page intentionally left blank

Appendix B: Model Codes

Model Code

The model code is identified as follows:

XXX Y Z C A E

- #####** = Type Number
- XXX** = Full Scale Range
- Y** = Fittings
- Z** = Valve
- C** = Connector
- A** = Seals

Type Number (#####)

This designates the model number of the instrument:

The mass flow monitor (no valve) is identified as the Type **179B**.

The mass flow controller (includes a control valve) is identified as the Type **1179B**.

The all metal sealed mass flow controller is identified as the Type **1479B**.

The mass flow controller equipped with a positive shutoff valve is identified as the Type **2179B**.

Full Scale Range (sccm nitrogen) (XXX)

The full scale range is indicated by two digits plus the letter C.

Full scale flow range (sccm)	Ordering Code
10	11C
20	21C
50	51C
100	12C
200	22C
500	52C
1000	13C
2000	23C
5000	53C
10.000	14C
20.000	24C

Table 4: Ordering Code - Ranges

Fittings (Y)

There are different fittings available, designated by a single letter code.

Fitting Type	Ordering Code
Cajon [®] 4-VCR [®] male	R
Cajon [®] 4-VCO [®] male	G
Swagelok [®] 1/4"	S
Swagelok [®] 6 mm	M
DN 16 KF	D

Table 5: Ordering Code - Fittings

Valve (Z)

Two valve configurations are available, designated by a single number code.

Valve Type	Ordering Code
Normally Closed (N.C.) Valve	1
No Valve (Type 179B only)	3

Table 6: Ordering Code - Valves

Connector (C)

The electrical connector of the analog version is designated by a letter, the connectors of the Profibus unit by a number.

Connector	Ordering Code
Analog Version (15 pol. Sub D)	B
Profibus Version (2 x 9 pol. Sub D)	4

Table 7: Ordering Code - Connectors

Seals (A)

The seal material is indicated by a single letter code.

Seal Material	Ordering Code
Viton [®] (Standard)	V
Neoprene [®]	N
Buna-N	B
Kalrez [®]	K
Metal	M

Table 8: Ordering Code - Seals

Appendix (F)

With Profibus units the type code ends with two to four digit code which includes the revision code.
Example:

.....26C1

Special versions end with a four digit code, consisting of a leading S followed by a three digit number. Example:

.....S211

Because of limited character length the revision number is then deleted.

Example: Ordering a flow monitor

To order a mass flow meter type 179B, analog version, 500 sccm full scale range, DN16KF fittings, no valve, 15-pol. Sub D connector, metal sealed, the product code is:

179B 52C D 3 B M

Example: Ordering Code of a Mass Flow Controller

To order a mass flow controller type 1179B, analog version, 100 sccm full scale range, 4-VCR fittings, valve, 15-pol. Sub D connector and Viton sealing material, the product code is:

1179BX 12C R 1 B V

Example: Ordering a Flow Controller (Profibus)

To order a mass flow controller type 1179B, Profibus version, 2000 sccm full scale range, 6 mm Swagelok fittings, Kalrez sealing material, software revision 2.6, the product code is:

1179B 23C M 1 4 K 26C1

Appendix C: Gas Correction Factors

Please read also the instructions in Chapter 8 and the notes at the end of this table.

GAS	SYMBOL	SPECIFIC HEAT, Cp cal/g°C	DENSITY g/l @ 0°C	CONVERSION FACTOR
Air	- - -	0.240	1.293	1.00
Ammonia	NH ₃	0.492	0.760	0.73
Argon	Ar	0.1244	1.782	1.39 ¹
Arsine	AsH ₃	0.1167	3.478	0.67
Boron Trichloride	BCl ₃	0.1279	5.227	0.41
Bromine	Br ₂	0.0539	7.130	0.81
Carbon Dioxide	CO ₂	0.2016	1.964	0.70 ¹
Carbon Monoxide	CO	0.2488	1.250	1.00
Carbon Tetrachloride	CCl ₄	0.1655	6.86	0.31
Carbon Tetrafluoride (Freon - 14)	CF ₄	0.1654	3.926	0.42
Chlorine	Cl ₂	0.1144	3.163	0.86
Chlorodifluoromethane (Freon - 22)	CHClF ₂	0.1544	3.858	0.46
Chloropentafluoroethane (Freon - 115)	C ₂ ClF ₅	0.164	6.892	0.24
Chlorotrifluoromethane (Freon - 13)	CClF ₃	0.153	4.660	0.38
Cyanogen	C ₂ N ₂	0.2613	2.322	0.61
Deuterium	D ₂	1.722	0.1799	1.00
Diborane	B ₂ H ₆	0.508	1.235	0.44
Dibromodifluoromethane	CBr ₂ F ₂	0.15	9.362	0.19
Dichlorodifluoromethane (Freon - 12)	CCl ₂ F ₂	0.1432	5.395	0.35
Dichlorofluoromethane (Freon - 21)	CHCl ₂ F	0.140	4.592	0.42
Dichloromethylsilane	(CH ₃) ₂ SiCl ₂	0.1882	5.758	0.25

(Table continued on next page)

GAS	SYMBOL	SPECIFIC HEAT, Cp cal/g°C	DENSITY g/l @ 0°C	CONVERSION FACTOR
Dichlorosilane	SiH ₂ Cl ₂	0.150	4.506	0.40
1,2-Dichlorotetrafluoroethane (Freon - 114)	C ₂ Cl ₂ F ₄	0.160	7.626	0.22
1,1-Difluoroethylene (Freon - 1132A)	C ₂ H ₂ F ₂	0.224	2.857	0.43
2,2-Dimethylpropane	C ₅ H ₁₂	0.3914	3.219	0.22
Ethane	C ₂ H ₆	0.4097	1.342	0.50
Fluorine	F ₂	0.1873	1.695	0.98
Fluoroform (Freon - 23)	CHF ₃	0.176	3.127	0.50
Freon - 11	CCl ₃ F	0.1357	6.129	0.33
Freon - 12	CCl ₂ F ₂	0.1432	5.395	0.35
Freon - 13	CClF ₃	0.153	4.660	0.38
Freon - 13 B1	CBrF ₃	0.1113	6.644	0.37
Freon - 14	CF ₄	0.1654	3.926	0.42
Freon - 21	CHCl ₂ F	0.140	4.592	0.42
Freon - 22	CHClF ₂	0.1544	3.858	0.46
Freon - 23	CHF ₃	0.176	3.127	0.50
Freon - 113	C ₂ Cl ₃ F ₃	0.161	8.360	0.20
Freon - 114	C ₂ Cl ₂ F ₄	0.160	7.626	0.22
Freon - 115	C ₂ ClF ₅	0.164	6.892	0.24
Freon - 116	C ₂ F ₆	0.1843	6.157	0.24
Freon - C318	C ₄ F ₈	0.185	8.397	0.17
Freon - 1132A	C ₂ H ₂ F ₂	0.224	2.857	0.43
Helium	He	1.241	0.1786	... ⁻²
Hexafluoroethane (Freon - 116)	C ₂ F ₆	0.1843	6.157	0.24
Hydrogen	H ₂	3.419	0.0899	... ⁻²
Hydrogen Bromide	HBr	0.0861	3.610	1.00
Hydrogen Chloride	HCl	0.1912	1.627	1.00
Hydrogen Fluoride	HF	0.3479	0.893	1.00
Isobutylene	C ₄ H ₈	0.3701	2.503	0.29
Krypton	Kr	0.0593	3.739	1.543
Methane	CH ₄	0.5328	0.715	0.72

(Table continued on next page)

GAS	SYMBOL	SPECIFIC HEAT, Cp cal/g°C	DENSITY g/l @ 0°C	CONVERSION FACTOR
Methyl Fluoride	CH ₃ F	0.3221	1.518	0.56
Molybdenum Hexafluoride	MoF ₆	0.1373	9.366	0.21
Neon	Ne	0.246	0.900	1.46
Nitric Oxide	NO	0.2328	1.339	0.99
Nitrogen	N ₂	0.2485	1.250	1.00
Nitrogen Dioxide	NO ₂	0.1933	2.052	. - - ²
Nitrogen Trifluoride	NF ₃	0.1797	3.168	0.48
Nitrous Oxide	N ₂ O	0.2088	1.964	0.71
Octafluorocyclobutane (Freon - C318)	C ₄ F ₈	0.185	8.937	0.17
Oxygen	O ₂	0.2193	1.427	0.993
Pentane	C ₅ H ₁₂	0.398	3.219	0.21
Perfluoropropane	C ₃ F ₈	0.194	8.388	0.17
Phosgene	COCl ₂	0.1394	4.418	0.44
Phosphine	PH ₃	0.2374	1.517	0.76
Propane	C ₃ H ₈	0.3885	1.967	0.36
Propylene	C ₃ H ₆	0.3541	1.877	0.41
Silane	SiH ₄	0.3189	1.433	0.60
Silicon Tetrachloride	SiCl ₄	0.1270	7.580	0.28
Silicon Tetrafluoride	SiF ₄	0.1691	4.643	0.35
Sulfur Dioxide	SO ₂	0.1488	2.858	0.69
Sulfur Hexafluoride	SF ₆	0.1592	6.516	0.26
Trichlorofluoromethane (Freon - 11)	CCl ₃ F	0.1357	6.129	0.33
Trichlorosilane	SiHCl ₃	0.1380	6.043	0.33
1,1,2-Trichloro - 1,2,2- Trifluoroethane (Freon - 113)	CCl ₂ FCCLF ₂ or (C ₂ Cl ₃ F ₃)	0.161	8.360	0.20
Tungsten Hexafluoride	WF ₆	0.0810	13.28	0.25
Xenon	Xe	0.0378	5.858	1.32

¹Empirically defined²Consult MKS Instruments, Inc. for special applications.

NOTE: Standard Pressure is defined as 1013,25 mbar (760 mmHg;14.7 psia), Standard Temperature is defined as 0°C.

This page intentionally left blank

Appendix D: Binary Code

The following table shows how to convert numbers from decimal code into binary code:

Decimal	Binary code
0	0000000
1	0000001
2	0000010
3	0000011
4	0000100
5	0000101
6	0000110
7	0000111
8	0001000
9	0001001
10	0001010
11	0001011
12	0001100
13	0001101
14	0001110
15	0001111
16	0010000
17	0010001
18	0010010
19	0010011
20	0010100
21	0010101
22	0010110
23	0010111
24	0011000
25	0011001
26	0011010
27	0011011
28	0011100
29	0011101
30	0011110
31	0011111
...	...
126	1111110
127	1111111

Table 9: Binary Code

This page intentionally left blank

MKS Worldwide Calibration & Service Centers

UNITED STATES

MKS Instruments, Inc.
Corporate Service Center
 651 Lowell Street
 Methuen, MA 01844
 Tel. (978) 682-4567
 Fax (978) 682-8543

MKS Instruments, Inc.
HPS Division,
Vacuum Components,
Valves & Gauging
 5330 Sterling Drive
 Boulder, CO 80301
 Tel. (303) 449-9861
 Tel. (800) 345-1967
 Fax (303) 442-6880

CANADA

MKS Instruments, Canada Ltd.
 30 Concourse Gate
 Nepean, Ontario, Canada K2E 7V7
 Tel. (613) 723-3386
 (800) 267-3551 (CAN only)
 Fax (613) 723-9160

FRANCE

MKS Instruments, France s.a.
 43, Rue du Commandant Rolland
 B.P. 41
 F-93352 Le Bourget, Cedex,
 France
 Tel. 33(1)48.35.39.39
 Telex 233817 F
 Fax 33(1)48.35.32.52

TAIWAN

MKS Instruments, Taiwan
 10F, No.93, Shoei-Yuan Street
 Hsinchu City 300
 Taiwan, R.O.C.
 Tel. 886-3-575 3040
 Fax 886-3-575 3048

GERMANY/BENELUX

MKS Instruments,
Deutschland GmbH
 Schatzbogen 43
 D-81829 München
 Tel. 49-89-420008-0
 Fax 49-89-42-41-06
 Email:mks-germany@mksinst.com

ITALY

G. Gambetti Kenologia Srl.
 Via A. Volta No. 2
 20082 Binasco (MI), Italy
 Tel. 39-2-90093082
 Fax 39-2-905.2778

JAPAN

MKS Japan, Inc.
 Harmonize Building
 5-17-13, Narita-Higashi
 Suginami-Ku, Tokyo 166, Japan
 Tel. 81-3-3398-8219
 Fax 81-3-3398-8984

KOREA

MKS Korea Co., Ltd.
 1st Floor DK Plaza-I
 375-1 Geumgok-dong
 Bundang-gu, Seongnam Kyonggi-do
 Korea 463-805
 Tel 82-31-717-9244
 Fax 82-31-714-9244

UNITED KINGDOM

MKS Instruments, U.K. Ltd.
 1 Anchorage Court
 Caspian Road
 Altrincham, Cheshire
 WA14 5HH, England
 Tel. 44-161-929-5500
 Fax 44-161-929-5511

Next page: Declaration of Contamination.

Contact your MKS location if the form is missing.



HEALTH AND SAFETY FORM

THIS FORM MUST BE COMPLETED AND RETURNED WITH EQUIPMENT OR SERVICE WILL NOT BE PERFORMED

RETURN MATERIAL AUTHORIZATION NUMBER (RMA#):	
RETURN TO STOCK NUMBER/RTS# (If applicable):	Trade in number (if applicable):

Section 1: (one instrument per form)	MKS Part Number:
	MKS Serial Number:

Section 2: Has this equipment been used? *(Please check appropriate boxes)*

<input type="checkbox"/>	No – Still in MKS packaging
<input type="checkbox"/>	No – Unit unpacked, but never installed in a system.
<input type="checkbox"/>	Yes -- Used only with clean, dry inert gas (For Example: Air, N2, Ar, He).
<input type="checkbox"/>	Yes -- Used with chemicals, non-inert gases, biological or radioactive agents.) Identify all materials:
<input type="checkbox"/>	Yes -- Used in a Semiconductor Copper process. Equipment must be double bagged. Label outside bag and packing slip, Copper Part. Label final shipping container Copper Part and place a strip of ORANGE TAPE on the container.
	Has equipment been purged? <input type="checkbox"/> No <input type="checkbox"/> yes purged with what?
	Has equipment been flushed? <input type="checkbox"/> No <input type="checkbox"/> yes flushed with what?
	Has equipment been decontaminated? <input type="checkbox"/> no <input type="checkbox"/> yes, explain process:
	How many months in use?

Section 3: Detailed failure information or description or required service or reason for return.

Section 4: Company or Organization (mandatory information)

Company:			
Address:			
City:	State:	Zip:	
Printed Name:		Signature:	
Date:		Phone #:	
Email:		Fax #:	
End User (if applicable):			

For MKS USE only:

MKS Subsidiary or Agent:
Contact Name:
Customer #
Maximum Credit allowed (TBD after inspection)

ALL PRODUCTS MUST BE RETURNED IN SEALED BAGS

MKS will not accept delivery of equipment that has been chemically, radioactively or biologically contaminated, without written evidence of decontamination or laboratory analysis. Alternately, we will require evidence that the biological process is not harmful.