



Allen-Bradley

POINT I/O DeviceNet Adapter

1734-ADN, 1734-ADNX

User Manual

**Rockwell
Automation**

Important User Information

Because of the variety of uses for the products described in this publication, those responsible for the application and use of these products must satisfy themselves that all necessary steps have been taken to assure that each application and use meets all performance and safety requirements, including any applicable laws, regulations, codes and standards. In no event will Rockwell Automation be responsible or liable for indirect or consequential damage resulting from the use or application of these products.

Any illustrations, charts, sample programs, and layout examples shown in this publication are intended solely for purposes of example. Since there are many variables and requirements associated with any particular installation, Rockwell Automation does not assume responsibility or liability (to include intellectual property liability) for actual use based upon the examples shown in this publication.

Allen-Bradley publication SGI-1.1, *Safety Guidelines for the Application, Installation and Maintenance of Solid-State Control* (available from your local Rockwell Automation office), describes some important differences between solid-state equipment and electromechanical devices that should be taken into consideration when applying products such as those described in this publication.

Reproduction of the contents of this copyrighted publication, in whole or part, without written permission of Rockwell Automation, is prohibited.

Throughout this publication, notes may be used to make you aware of safety considerations. The following annotations and their accompanying statements help you to identify a potential hazard, avoid a potential hazard, and recognize the consequences of a potential hazard:

WARNING

Identifies information about practices or circumstances that can cause an explosion in a hazardous environment, which may lead to personal injury or death, property damage, or economic loss.

ATTENTION

Identifies information about practices or circumstances that can lead to personal injury or death, property damage, or economic loss.

IMPORTANT

Identifies information that is critical for successful application and understanding of the product.

Using Change Bars

This document contains updated information. Changes are identified by change bars in the margin, as shown to the left.

New and Revised Information

The table below lists the new and revised information included in this release of the POINT I/O DeviceNet Adapter user manual.

Table Summary of Changes.A

Information about	New or revised:	Location:
Guidelines for Using Your Adapter	New	Preface Chapter 6
Using Auto Start Mode	New	Chapter 2 Chapter 3 Appendix B
Using the Cycling I/O Mapping Feature	New	Chapter 2 Chapter 3
Removing and Reinserting Modules on the DeviceNet Network	New	Chapter 2
1734-ADNX Quick Start	New	Appendix B
1734-ADNX Rules and Guidelines on How to Use the 1734-ADNX	New	Appendix C
Use Default Data Maps	New	Appendix D

Notes:

Purpose of this Manual

This manual describes how to install, configure and operate your POINT I/O DeviceNet™ Adapter, catalog number 1734-ADN.

For more information about:	See page:
Who Should Use This Manual	Preface-1
What the Manual Contains	Preface-2
Related Terms	Preface-3
Related Products and Documentation	Preface-5
Guidelines for Using Your Adapter	Preface-5
Conventions Used in This Manual	Preface-6

IMPORTANT

In this manual, we use 1734-ADN(X) to refer to both the 1734-ADN and 1734-ADNX modules. We use 1734-ADN to refer to only the 1734-ADN module. We use 1734-ADNX to refer to only the 1734-ADNX module.

In the rest of this manual (except Chapter 4), we refer to the 1734-ADN(X) POINT I/O DeviceNet adapter as the adapter.

In Chapter 4, we refer to the POINT I/O DeviceNet adapter as the scanner because the chapter describes how to configure the adapter for use with POINT I/O modules.

Who Should Use This Manual

You must be able to use RSNetWorx™ for DeviceNet software or similar configuration software to configure your adapter.

In this manual, we assume you know how to configure an adapter. If you do not, refer to your software user manuals or online help before attempting to use this adapter.

We also assume you are familiar with the POINT I/O product line, including other fieldbus interfaces, I/O modules and power supplies. If you are not familiar with these components, you can read some of the POINT I/O documents listed on page Preface-5.

What the Manual Contains

This manual contains the following sections:

Chapter 1 - Installing the 1734-ADN(X) Adapter

Description of how to install and wire the adapter

Chapter 2 - What is the 1734-ADN(X) Adapter?

Overview of the adapter's features and functionality

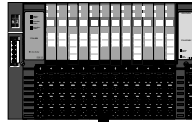
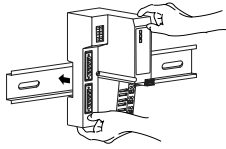

Chapter 3 - Using Auto Start Mode

Description of how to use the Auto Start Mode on your adapter to quickly get your system up and running

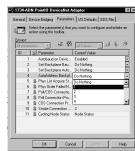

Or

Chapter 4 - Configuring the 1734-ADN(X) Adapter's SubNet

Description of how to configure your adapter

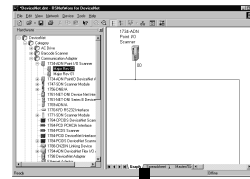

Chapter 5 - Adding the 1734-ADN(X) to the DeviceNet Scanner's Scanlist

Description of how to configure the DeviceNet adapter and to add it to the scanlist.

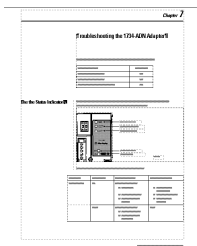

Chapter 6 - Troubleshooting the 1734-ADN(X) Adapter

Description of how to use the status indicators and to troubleshoot your adapter

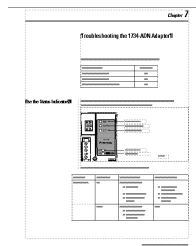

Appendix A - Specifications

Listing of the 1734-ADN(X) specifications



Appendix B - Quick Start

Learning how to use the 1734-ADNX with a ControlLogix system on DeviceNet

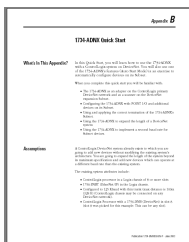

Appendix C - 1734-ADNX Rules and Guidelines

Regarding how to use the 1734-ADNX

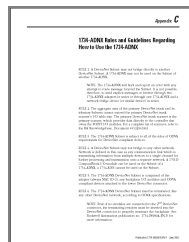

Appendix D - Default Data Maps

Listing of the default data maps for 1734-POINT I/O modules

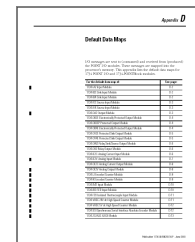

Related Terms

This manual uses the following terms:

Term:	Definition:
Adapter	POINT I/O DeviceNet adapter (1734-ADN and 1734-ADNX).
Auto Catalog Replace	The POINT I/O DeviceNet adapter supports the swapping of two identical modules connected to the adapter. I.e., if a 1734-IB4 is in slot 3 and another 1734-IB4 is in slot 7, the two modules can be removed from the POINT system and the slot 3 module placed into slot 7, and vice-versa. When ADR is active, the swapped modules will be reconfigured to match the previous module in their new slot. When ADR is not active, the configuration parameters will not be modified, the swapped modules must have identical configuration, and values for their EDS file parameters.
Auto Device Replace	This refers to the ADR feature of a ControlLogix System on DeviceNet. With ADR active, any device on the DeviceNet link may be removed and replaced with an out-of-the-box checkmark compliant DeviceNet device. The ADR feature will result in downloading the values of the configuration parameters of the EDS file, of the removed device, to the new device.
Auto Start Mode	A feature that lets the POINT I/O system get "up and running" without the prerequisite to configure any of the EDS parameters for the POINTBus™ or POINT I/O modules. Using Auto Start Mode will result in a scan list within the adapter which stores the modules identity information.
Autobaud	Feature in devices (e.g. POINT I/O modules) on the DeviceNet network that causes them to listen to communications on the network and set their own baudrate to match the network rate.
Backplane	The PointBus that consists of POINT I/O modules connected to the 1734-ADN(X) adapter.
Baudrate	Rate of communications between devices on the DeviceNet network. Backplane baudrate is used for the 1734-ADN. Subnet baudrate is used for the 1734-ADNX.
Change of State (COS)	DeviceNet communications method in which the adapter sends data based on detection of any changed value within the input data. Data is independently received based on change of state from the sender. Data in both directions can be acknowledged or unacknowledged depending on the run time configuration of the system.
Commissioning	The period in time associated with post startup activities. Commissioning implies that the system has been validated and all configuration parameters are correct, all modules are in good operating condition, and the adapter scanlist is complete.
ControlFlash	Utility software you can use to update the adapter's firmware with the most current Boot and Application code.

Term:	Definition:
Cyclic	DeviceNet communications method in which the adapter sends data cyclically based on a configured time value. Data is independently received cyclically from the sender. Data in both directions can be acknowledged or unacknowledged depending on the run time configuration of the system.
MAC ID	Media Access Control Identifier (DeviceNet network address).
Master	A DeviceNet network device (e.g., 1771-SDN) that initiates communication with DeviceNet slave devices (e.g., POINT I/O modules) to retrieve data. The master only receives unprompted data when the slave is enabled for COS and there is a change in the device's operating state.
MAX BACKPLANE ID	A unique attribute, Max(imum) Backplane MACID , has been added to 1734-ADNX. This value represents the highest node address of a module residing on the backplane. This value must be greater than or equal to the rightmost backplane POINT I/O module, but must be less than that of any non-backplane Subnet module.
Offline	State of the adapter when it is not powered or maintaining normal communications exchanges with other DeviceNet devices.
Online	State of the adapter when it is powered and maintaining normal communications exchanges with other DeviceNet devices.
PointBus	The POINT I/O backplane. PointBus maintains all DeviceNet network protocol but also offers configuration capabilities.
Polled	DeviceNet communications method in which a module sends data in response to received data.
Primary Network	The Primary DeviceNet Network, and it is defined as the DeviceNet link that provides the direct connection between the POINT DeviceNet adapter and a DeviceNet scanner
RSNetWorx for DeviceNet	Configuration software for the adapter and Subnet modules.
Scanlist	The list of Subnet modules connected to the adapter. When ADR is active, the scanlist stores the configured values of each of the Subnet modules' configurable parameters. When ADR is not active, the scanlist stores only the module identity information.
Scanner	Operating state of the 1734-ADN(X) when it retrieves I/O data from Subnet modules.
Slave	A DeviceNet network device that cannot initiate communication (except when configured with COS enabled) but responds to a DeviceNet master device.
Strobe	Adapter sends data in response to the strobe command. The single bit allocated to the adapter in the strobe message is not used. If the configured size of the input data (sent from the adapter) is greater than 8 bytes, the strobe connection establishment will fail. In this case, the input size must be reconfigure to 8 bytes or less.

Term:	Definition:
Subnet	1734-ADNX only. The Subnet DeviceNet Network, and is defined as the DeviceNet link that provides the expansion of the POINTBus to allow the 1734-ADNX to use its lower connector to add an additional 500 meters and up to 63 nodes which will be bridged through the 1734-ADNX up to the Primary Network. Note that backplane modules are also part of the Subnet.

Related Products and Documentation

The following table lists related POINT I/O products and documentation:

Document	Cat. No.	Publication
POINT I/O Technical Data	1734-Series	1734-TD002
POINT I/O Digital and Analog I/O Modules and POINTBlock I/O Modules User Manual	1734-Series and 1734D-Series	1734-UM001
POINT I/O Module Installation Instructions	1734-Series	1734-INxxx (Multiple numbers)
DeviceNet Communication Interface Installation Instructions	1734-PDN	1734-IN057
POINT I/O 24V dc Expansion Power Supply Installation Instructions	1734-EP24DC	1734-IN058
Field Potential Distributor Installation Instructions	1734-FPD	1734-IN059
General Installation Instructions	All 1734	1734-IN510
Wiring Base Assembly Installation Instructions	1734-TB, -TBS	1734-IN511
Wiring Base Assembly Installation Instructions	1734-TB3, -TB3S	1734-IN013
Terminal Marking Kit	1492-PLTKIT	1492-UM001 and 1492-5.0
DeviceNet Cable System Planning and Installation Manual	DN-6.7.2	DN-6.7.2
Industrial Automation Wiring and Grounding Guidelines	N/A	1770-4.1

If you need more information on these products, contact your local Rockwell Automation/Allen-Bradley distributor, integrator or sales office for assistance. For more information on the documentation, refer to the Allen-Bradley Publication Index, publication SD499.

Guidelines for Using Your Adapter

Remember the following operational guidelines when using your 1734-ADN(X) adapter.

- Do not leave spaces in the I/O. Instead, install all POINT I/O modules adjacent to each other.

IMPORTANT

If you must leave an I/O space open temporarily, you must change the keying position on the mounting base (1734-MB) to #5. This position will prevent you from installing the wrong I/O module on the base.

- Populate every position on the DIN rail.
- Do not add new I/O modules to the end of the POINT I/O system while the system is under power.
- Use both labels with the I/O modules and removable terminal blocks (RTBs).
- Do not separate I/O modules and RTBs with the same number.
- Do not move I/O modules to different locations on the DIN rail after they have been installed and configured. You should always place modules with the matching RTB.
- If adjacent modules (i.e., 2 or more) are removed, replace all of them to operate the POINT I/O system. Input data will hold last state until all previously-removed modules are replaced.
- Use Allen-Bradley terminal markers to identify your POINT I/O modules. The cards are easily ordered from your Rockwell Automation representative under the Bulletin 1492 number.

For more information on the Allen-Bradley terminal marking kits, see the documents list on page Preface-5.

Conventions Used In This Manual

The following conventions are used throughout this manual:

- bullet lists (such as this one) provide information, not procedural steps
- number lists provide sequential steps
- text **written like this** identify screen, menu, toolbar names, field names, buttons, and check boxes on screens
- a menu item in this format **File>Save** identifies the submenu item after the caret (>) accessed from the main menu (name before the caret)
- pictures of symbols and/or screens represent the actual symbols you see or the screens you use

	Chapter 1	
Installing the 1734-ADN(X) Adapter	Installing the Adapter	1-2
	Installing a Replacement DeviceNet Adapter in an Existing System.	1-4
	Wiring the Adapter	1-5
	DeviceNet Connection Plug Wiring and Subnet.	1-6
	Chapter Summary and What's Next	1-6
	Chapter 2	
What is the 1734-ADN(X) Adapter?	Using the Adapter.	2-2
	Set Subnet/Backplane Baudrate	2-3
	Set Subnet I/O Module Addresses.	2-3
	Configure the Subnet I/O.	2-4
	Configure the Primary DeviceNet Network	2-4
	Remove and Reinsert Modules on the Backplane	2-5
	Understanding the DeviceNet Network and Subnet	2-6
	DeviceNet Network	2-6
	Subnet Network.	2-6
	Adapter Features.	2-8
	Communicating Through the Adapter	2-18
	Mapping Data	2-18
	Overview of the Communication Process	2-19
	Image Table Mapping	2-20
	Communicating with I/O Modules.	2-22
	Using Diagnostic Tables	2-23
	Chapter Summary and What's Next	2-24
	Chapter 3	
Using Auto Start Mode	Why Use Auto Start Mode?	3-2
	What Does Auto Start Mode Do?.	3-2
	When the Adapter Uses Auto Start Mode, How Does it Map I/O Data?.	3-3
	Are There Any Requirements to Using Auto Start Mode?	3-4
	Installing the Adapter	3-4
	Wiring the Adapter	3-7
	DeviceNet and Subnet Connector Plug Wiring.	3-8
	Installing the I/O Modules.	3-8
	Adding Non-Backplane Modules to Subnet (1734-ADNX Only)	3-9
	Using RSNetWorx for DeviceNet	3-10
	Beginning Auto Start Mode	3-11
	Using Custom Configuration	3-13
	Chapter Summary and What's Next	3-14

Configuring the 1734-ADN(X) Adapter's SubNet	Chapter 4	
	Configuration Overview	4-1
	Adding the Scanner to Your Network	4-2
	Adding I/O Modules to Your Network	4-3
	Setting the Scanner's Parameters	4-3
	Going Online.	4-8
	Chapter Summary and What's Next	4-8
Adding the 1734-ADN(X) to the DeviceNet Scanner's Scanlist	Chapter 5	
	Configuration Overview	5-1
	Adding the Adapter to Your Network	5-2
	Setting the Adapter's Parameters	5-3
	Going Online.	5-6
	Chapter Summary and What's Next	5-6
Troubleshooting the 1734-ADN(X) Adapter	Chapter 6	
	Use the Status Indicators	6-1
	Guidelines for Using Your Adapter	6-4
	Chapter Summary and What's Next	6-5
Specifications	Appendix A	
1734-ADNX Quick Start	Appendix B	
	What's In This Appendix?	B-1
	Assumptions	B-1
	Review of the 1734-ADNX Rules and the MAC ID Parameter	B-9
	Review of Auto Start Mode	B-11
	Browse the Subnet.	B-15
	Inputs and Outputs	B-18
	Navigate Between Networks.	B-23
1734-ADNX Rules and Guidelines	Appendix C	
Regarding How to Use the 1734-ADNX. Default Data Maps	Appendix D	
	1734-IA2 Input Module	D-2
	1734-IB2 Sink Input Module	D-2
	1734-IB4 Sink Input Module	D-2
	1734-IV2 Source Input Module	D-3
	1734-IV4 Source Input Module	D-3
	1734-OA2 Output Module	D-3
	1734-OB2E Electronically Protected Output Module	D-4

1734-OB2EP Protected Output Module	D-4
1734-OB4E Electronically Protected Output Module . . .	D-4
1734-OV2E Protected Sink Output Module	D-5
1734-OV4E Protected Sink Output Module	D-5
1734-OW2 Relay Sink/Source Output Module	D-6
1734-OX2 Relay Output Module	D-6
1734-IE2C Analog Current Input Module	D-6
1734-IE2V Analog Input Module	D-7
1734-OE2C Analog Current Output Module	D-8
1734-OE2V Analog Output Module	D-8
1734-IJ Encoder/Counter Module	D-9
1734-IK Encoder/Counter Module	D-9
1734-IM2 Input Module	D-10
1734-IR2 RTD Input Module	D-10
1734-IT2I Isolated Thermocouple Input Module	D-11
1734-VHSC 24V dc High Speed Counter Module	D-11
1734-VHSC 5V dc High Speed Counter Module	D-12
1734-SSI Synchronous Serial Interface Absolute Encoder Module	D-12
1734-232ASC ASCII Module	D-13

Installing the 1734-ADN(X) Adapter

This chapter describes how to install and wire your adapter.

For more information about:	See page:
Installing the Adapter	1-2
Installing a Replacement DeviceNet Adapter in an Existing System	1-4
Wiring the Adapter	1-5
Chapter Summary and What's Next	1-6

When properly installed, POINT I/O is grounded through the DIN rail to chassis ground. We recommend using zinc plated, yellow chromated steel DIN rail to assure proper grounding.

Other DIN rail materials (e.g. aluminum, plastic, etc.) can corrode or oxidize and are poor conductors that may result in improper or intermittent platform grounding.

If you choose not to use zinc plated, yellow chromated steel DIN rail for your POINT I/O, we recommend occasional cleaning of the DIN rail to prevent or lessen the effects of oxidation and corrosion.

Installing the Adapter

To install the adapter on the DIN rail prior to installing other base units, proceed as follows.

1. Position the adapter vertically in front of the DIN rail.
2. Press firmly to install the adapter on the DIN rail. The locking mechanism locks the adapter to the DIN rail.

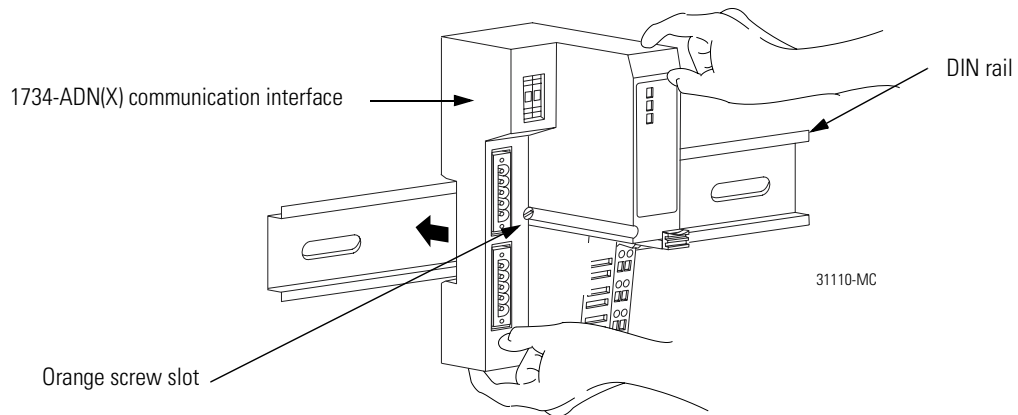

3. Insert the DeviceNet network plug and tighten the holding screws.

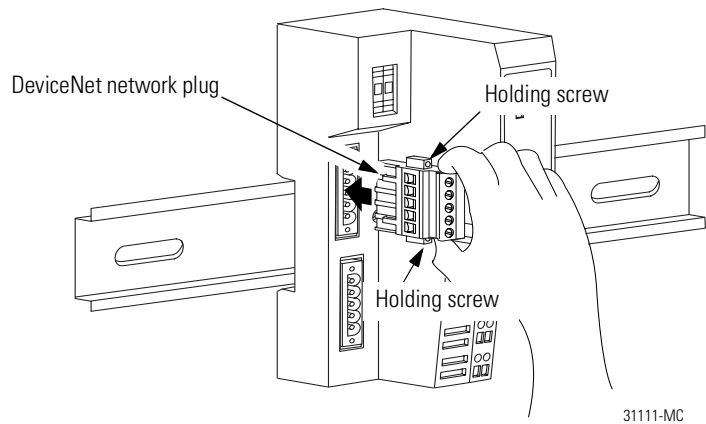

4. Set the node address using the 2-position thumbwheel switch. Valid physical settings range from 00 to 63. Press either the + or - buttons to change the number.

You can also set the node address to some value between 64-99. In this case, you can change the adapter's node address via the RSNetWorx for DeviceNet software. If a value between 64-99 is used, at power-up the node address stored in the adapter's non-volatile memory is used.

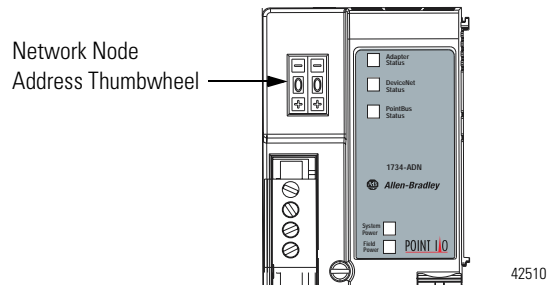

5. Slide the safety end cap up to remove it. This exposes the backplane and power interconnections.

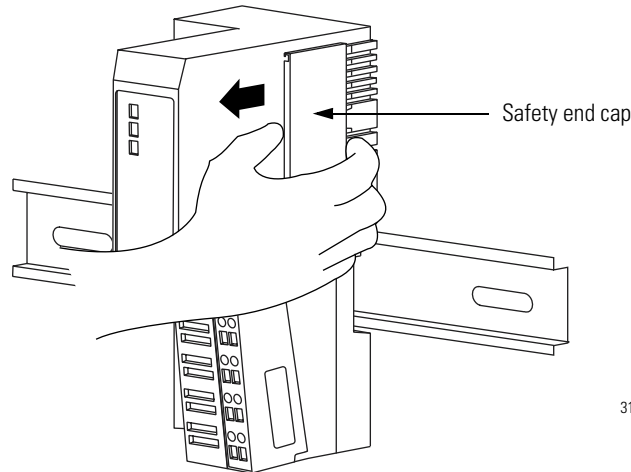

ATTENTION



Do not discard the safety end cap. Use this end cap to cover the exposed interconnections on the last mounting base on the DIN rail. Failure to do so could result in equipment damage or injury from electric shock.

Installing a Replacement DeviceNet Adapter in an Existing System

Your existing control application may be using another DeviceNet adapter (e.g., 1734-PDN) that you want to replace with a 1734-ADN(X) DeviceNet adapter. Remove the existing adapter from the DIN rail as follows:

1. Eliminate power to the adapter and all I/O modules in your existing system.
2. Remove the wiring assembly and DeviceNet cable from your existing adapter.
3. Remove the adjacent I/O module.

For information on how to remove POINT I/O modules from the DIN rail, see the associated publications for those modules.

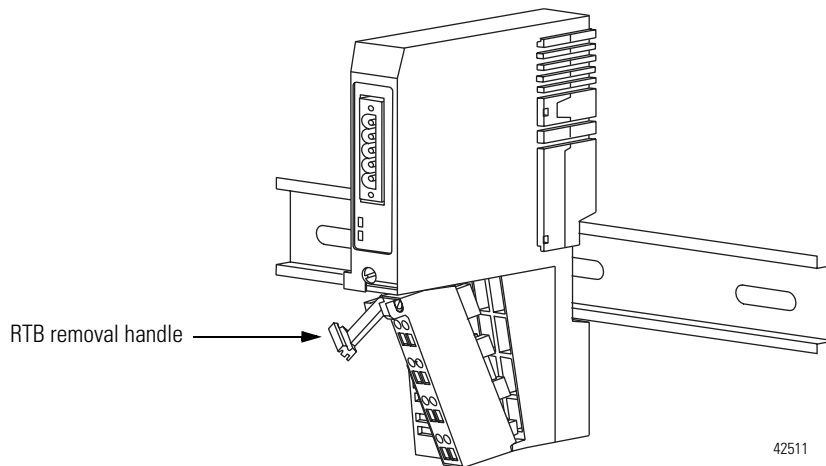

4. Use a small bladed screwdriver to rotate the DIN rail locking screw to a vertical position and release the locking mechanism.

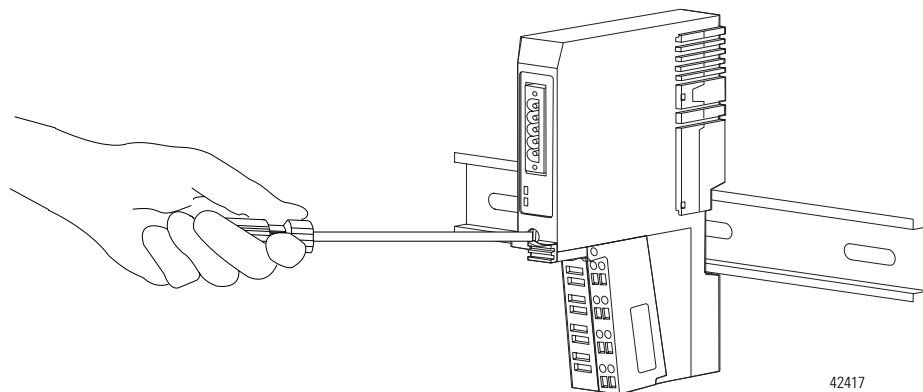

5. Pull the adapter off of the DIN rail to remove it from the existing system.

6. Insert the new adapter into slot 0 using the steps described on page 1-2.
7. Reattach I/O modules to the new adapter.

■ Wiring the Adapter

Your adapter's wiring and network designations are shown below.

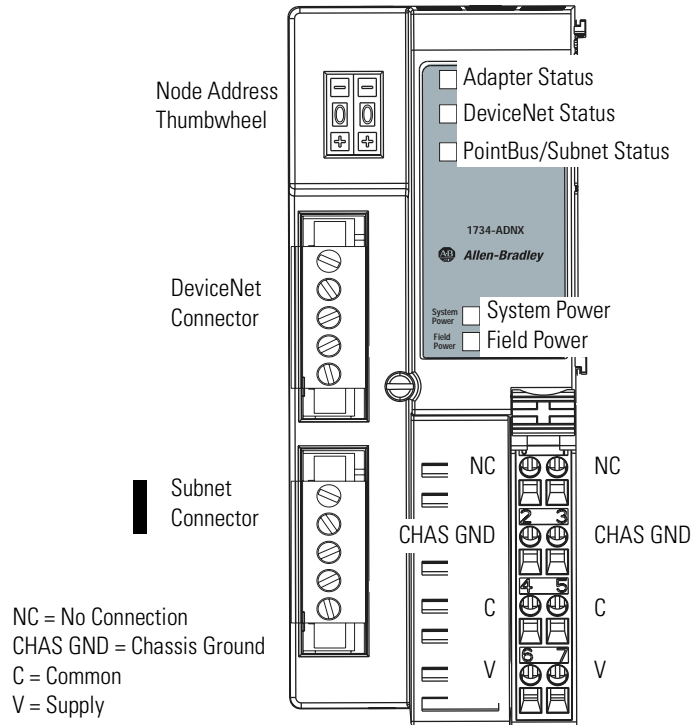

Adapter/Field Power 12/24V dc

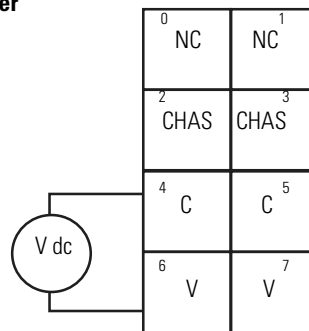

This dc supply is connected to the internal power bus.

You cannot supply power to the adapter from the DeviceNet power supply.

42513

NC = No Connection
 C = Common

CHAS GND = Chassis Ground
 V = Supply (Do not connect 120/240V ac power to this supply.)

Terminal		Notes
0	No connection	Reserved
1	No connection	
2	Chassis Ground	
3	Chassis Ground	
4	Common	
5	Common	
6	Voltage Input	Apply 12/24V dc. Connects to the internal power bus.
7	Voltage Input	

DeviceNet Connection Plug Wiring and Subnet

DeviceNet connection	Black	1	-V
	Blue	2	CAN - Low
	Bare	3	Shield
	White	4	CAN - High
	Red	5	+V

42514

Chapter Summary and What's Next

In this chapter, you learned how to install and wire your adapter. Move to chapter 2 to learn about the 1734-ADN(X) adapter.

What is the 1734-ADN(X) Adapter?

This chapter describes the POINT I/O DeviceNet adapter, including descriptions of the adapter's features and functionality.

For more information about:	See page:
Using the Adapter	2-2
Understanding the DeviceNet Network and Subnet	2-6
Adapter Features	2-8
Auto Start Mode	2-9
Communicating Through the Adapter	2-18
Communicating with I/O Modules	2-22
Using Diagnostic Tables	2-23
Chapter Summary and What's Next	2-24

Using the Adapter

The adapter resides on the primary DeviceNet network and the Subnet simultaneously.

IMPORTANT

The PointBus maintains all DeviceNet network protocol but also offers configuration capabilities.

From this position, the adapter interfaces between DeviceNet devices and POINT I/O modules. The graphic below shows the adapter on the DeviceNet network and PointBus.

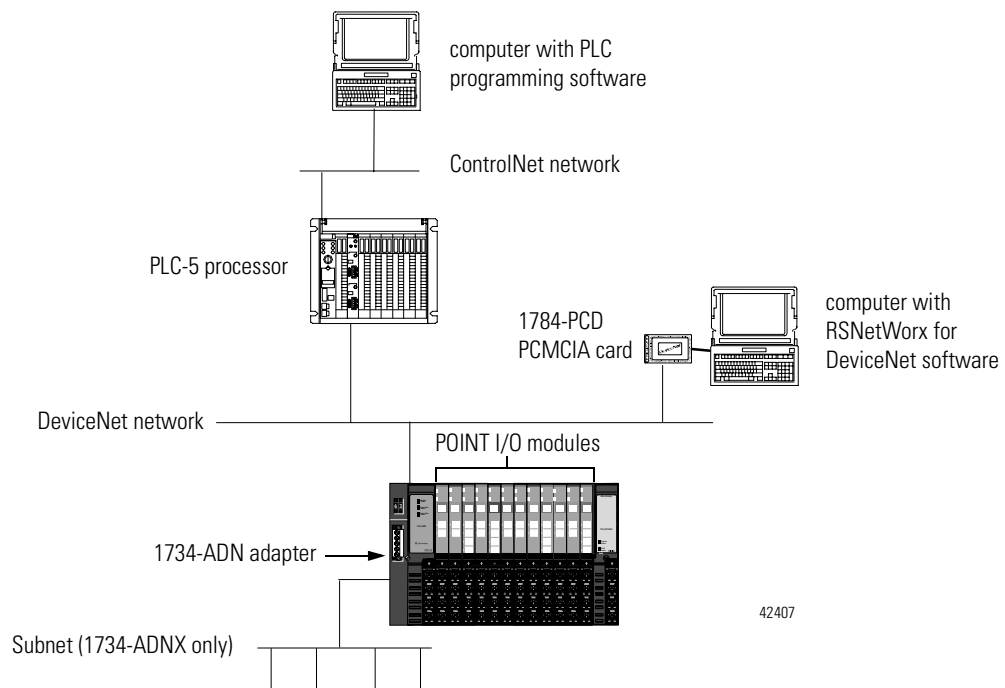

After you have installed your adapter into a POINT I/O system, you must perform the following tasks:

1. Set Subnet/Backplane Baudrate
2. Set Subnet I/O Module Addresses
3. Configure the Subnet I/O
4. Configure the Primary DeviceNet Network

The steps mentioned above are explained briefly here and then in greater detail throughout this manual. You must complete the steps for the adapter to work with DeviceNet masters (e.g., 1756-DNB) on the primary network and Subnet modules.

Set Subnet/Backplane Baudrate

The adapter and Subnet modules must use the same baudrate to communicate with each other. Use one or both of the following to set a Subnet baudrate.

- Enable or disable the Backplane Autobaud feature for POINT I/O modules. POINT I/O modules have Autobaud enabled as the default- See page 2-12.
- Set the adapter baudrate for the Subnet. The default for the 1734-ADN is 1Mbaud. The default for the 1734-ADNX is 125Kbaud - See page 2-9.

IMPORTANT

You set the backplane baudrate for the 1734-ADN.
You set the Subnet baudrate for the 1734-ADNX.

Set Subnet I/O Module Addresses

Once the adapter and POINT I/O modules are communicating at the same rate on the backplane, you must make sure all modules use a valid MAC ID.

Set the Auto Address feature for POINT I/O modules - See page 2-13.

Configure the Subnet I/O

In the first two steps, you set a consistent communication rate and made sure each module uses address for communication. Next you must configure the PointBus (e.g., set scan list).

You can configure the PointBus using one of two methods: Auto Start Mode (ASM) or manually. For more information on configuring the PointBus using ASM, see Chapter 3 or see Chapter 4 for manual configuration.

Configure the Primary DeviceNet Network

Finally, you must configure the adapter for communication with a master (e.g., 1756-DNB).

For more information on configuring the DeviceNet network, see Chapter 5, Adding the 1734-ADN(X) to the DeviceNet Scanner's Scanlist.

You must understand all of the adapter's features to effectively use it in your POINT I/O system. Keep these four steps in mind as you read this manual:

1. Set Subnet Baudrate
2. Set Subnet I/O Module Addresses
3. Configure the Adapter's Scanlist
4. Configure the Primary DeviceNet Network

Remove and Reinsert Modules on the Backplane

POINT I/O modules can easily be removed and reinserted on the 1734-ADN(X) backplane. If the removal and reinsertion is not done with caution, you can affect the adapter's operations and, consequently, the entire POINT I/O application.

If you must remove and reinsert modules, we recommend the following:

- Do not move I/O modules to different locations on the DIN rail after they have been installed and configured.
- Always place modules with the matching Removable Terminal Block.
- If adjacent modules (i.e., 2 or more) are removed from the backplane, replace all of them before attempting to operate the POINT I/O system. Input data will hold last state until all previously-removed modules are replaced.

IMPORTANT

The 1734-ADN(X) can only detect the location of POINT I/O modules residing on the 1734-ADN(X) backplane. It is the user's responsibility to maintain all non-backplane devices, including POINT I/O modules attached to the Subnet with a 1734-PDN adapter.

-
- If adjacent modules are removed and all but one is returned, the adapter cannot verify the location of the returned modules. For example, if modules are removed from nodes 3 and 4 and only the module from node 4 is returned, the adapter cannot verify the location. In this case, the adapter alerts you (via RSNetWorx for DeviceNet) that it cannot verify the presence of modules in the affected locations. I/O data will not be exchanged with this node until both modules have been reinserted.
 - If modules of **different types** are removed and returned to the wrong locations, the adapter identifies the returned modules and alerts you (via RSNetWorx for DeviceNet) that the error has occurred and must be corrected.

- If modules of the **same type** are removed and returned to the wrong locations, the adapter identifies the returned modules, updates their MAC IDs and continues operation.

IMPORTANT

The removal and return scenario exists whether the system is under power or not. If the system is under power, the scenario arises immediately. If the system is not under power, the scenario arises in the next power cycle.

Also, the example above shows removal of two adjacent modules. The scenario described exists anytime 2 or more adjacent modules are removed and not all are returned.

IMPORTANT

Care must be taken when replacing backplane I/O modules. Each I/O module stores its configuration parameters in internal non-volatile memory. You must either enable ADR for all modules or manually configure each module in a non-manufacturing environment when the module is being replaced or placed on the network for the first time. Failure to do so could result in inadvertent control attributed to different configuration settings.

Understanding the DeviceNet Network and Subnet

DeviceNet Network

Your adapter serves as a slave to DeviceNet masters. The adapter receives data from and returns data to the master through the following I/O connections:

- Change of State (COS)
- Cyclic
- Polled
- Strobe

Subnet Network

On the Subnet, your adapter acts as a scanner and is the master of the Subnet modules. The adapter performs the following functions:

- Exchanges I/O data with devices on Subnet

- Collects I/O data from the Subnet and sends it to devices on the DeviceNet network (e.g., scanners or controllers)
- Supplies power to the backplane I/O modules (See Appendix A for power supply rules regarding I/O modules power requirements.)

Data Collection

The adapter collects I/O data from up to 63 modules via the Subnet. The I/O modules appear on the primary DeviceNet network as a single node, though, and require only one DeviceNet node address.

IMPORTANT

If Automatic Device Replacement (ADR) is enabled on the adapter, you can only connect up to 62 modules via the Subnet.

For more information on ADR, see page 2-15.

Module Power

The adapter supplies 5V logic power to POINT I/O modules by converting 24V dc field power to PointBus 5V power.

You can connect up to 63 I/O modules to each adapter, and you can power to the backplane I/O modules from the adapter (with a maximum of 10A of field power). You may use the integrated, isolated 24V dc expansion power unit (1734-EP24DC) to power additional I/O modules, as shown below.

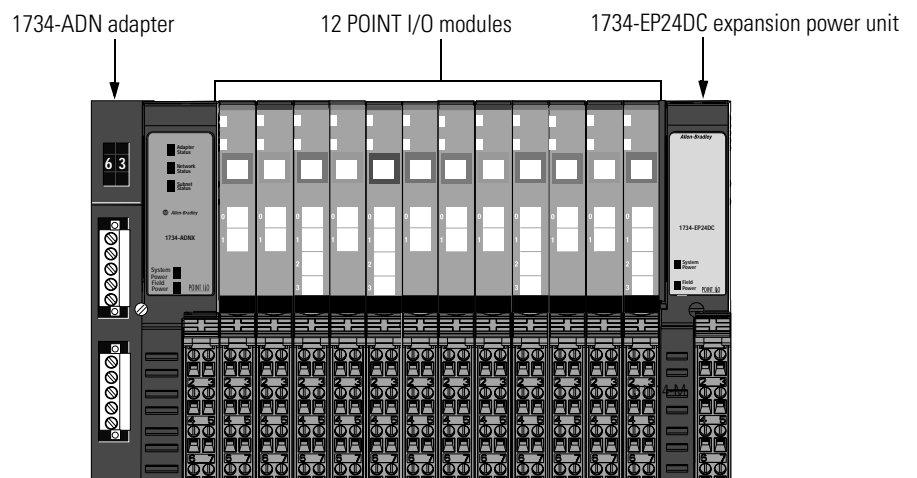

For more information on the 1734-EP24DC expansion power unit, see:

- POINT I/O Technical Data, publication 1734-TD002
- POINT I/O 24V dc Expansion Power Supply Installation Instructions, publication 1734-IN058

■ Adapter Features

Your adapter uses the following features on both the DeviceNet network and the PointBus:

- Self-Test
- Field Upgradable Firmware
- Fully Software Configurable
- Connections
- Baudrates

Self-Test

On power-up, the adapter performs a self-test. The adapter tests various internal and programmatic memories and checks the status indicators (LEDs).

Field Upgradable Firmware

You can update the adapter's firmware with the ControlFlash Utility software. This feature lets you always use the most current application code.

Fully Software Configurable

The adapter is fully software configurable using RSNetWorx for DeviceNet. You must configure the adapter for use with a DeviceNet master (e.g., 1756-DNB) and separately for use with Subnet devices.

For more information on how to configure your adapter for use with a DeviceNet master, see Chapter 5.

For more information on how to configure your adapter for use with Subnet modules, see Chapter 4, Configuring the 1734-ADN(X) Adapter's SubNet.

Connections

Your adapter supports the following connections on both the primary DeviceNet network and Subnet:

- I/O connections:
 - Polled
 - Strobe
 - Cyclic
 - COS
- Explicit connections

You can use I/O mapping to determine the data contained in each connection.

The adapter supports Master/Slave connection types on the **DeviceNet** network. On the **Subnet**, the adapter functions as a scanner device, exchanging data with I/O modules.

Baudrates

Choose baudrates for the adapter in the RSNetWorx for DeviceNet software. It supports these rates:

- 125Kbaud
- 250Kbaud
- 500Kbaud
- Autobaud - The adapter detects the primary DeviceNet network baudrate and automatically sets its own baudrate to match the network.
- For the 1734-ADN, the PointBus can be configured to operate at 1Mbaud (1000Kbaud).

Auto Start Mode

Auto Start Mode lets you easily get your adapter installed and operating. In this mode, the adapter's configurable features operate as they were most recently configured. For example, if Autobaud on DeviceNet was enabled in the adapter's last configuration, it will be enabled when Auto Start Mode is used.

For a more detailed explanation of how to use Auto Start Mode, see Chapter 3.

Auto Catalog Replace

Auto Catalog Replace corrects errors that might occur when backplane modules of the same type are removed and replaced in the wrong location. If modules of the **same type** are removed and returned to the wrong locations, the adapter identifies the returned modules, updates their MAC IDs and continues operation.

IMPORTANT

If modules of **different types** are removed and returned to the wrong locations, the adapter identifies the returned modules and alerts you (via RSNetWorx for DeviceNet, the Node Status Table, and the Faulted Node Table) that the error has occurred and must be corrected.

IMPORTANT

The removal and return scenario exists whether the system is under power or not. If the system is under power, the scenario arises immediately. If the system is not under power, the scenario arises in the next power cycle.

Also, the example above shows removal of two adjacent modules. The scenario described exists anytime 2 or more adjacent modules are removed and not all are returned.

IMPORTANT

Care must be taken when replacing backplane I/O modules. Each I/O module stores its configuration parameters in internal non-volatile memory. You must either enable ADR for all modules or manually configure each module in a non-manufacturing environment when the module is being replaced or placed on the network for the first time. Failure to do so could result in inadvertent control attributed to different configuration settings.

Backplane (1734-ADN)/Subnet (1734-ADNX) Baudrate

EDS parameter Backplane Baudrate is accessible from the primary DeviceNet and sets a specific baudrate for all backplane I/O modules.

Set this parameter in RSNetWorx for DeviceNet to one of the following baudrates:

- 125 Kbaud
- 250 Kbaud
- 500 Kbaud
- 1 Mbaud (available with the 1734-ADN only)

When you download this parameter, the adapter sends a command to reset all present I/O modules on the backplane to the new baudrate. If additional modules are connected to the adapter, you must download the Backplane/Subnet Baudrate to make sure the new modules use the same rate as the others.

The baudrate may not take effect until power is recycled or the I/O modules are reset.

IMPORTANT

Changes to the Backplane/Subnet Baudrate parameter only take effect if they are downloaded on an individual basis (e.g., If you change the Backplane/Subnet Baudrate and download the changes with additional changes to other features, the Backplane/Subnet Baudrate remains at the previous setting).

Also, this parameter should be set to “Do Nothing” when you download all parameters or when Automatic Device Replacement is enabled for the adapter.

If you want to set an I/O module to use a specific baudrate (i.e., 125, 250, 500), you must first disable Backplane Autobaud for that module.

Backplane/Subnet Baudrate performs the following functions:

- Sets the adapter’s Subnet baudrate
- Sends a message to all connected backplane I/O modules. If an I/O module is set to autobaud, it receives the message but ignores the new baudrate.

Backplane Autobaud

The adapter itself never autobauds on the Subset. Backplane Autobaud automatically enables or disables Autobaud for all I/O modules currently attached to the backplane. The adapter does not set a specific rate, though (as with Backplane Baudrate).

If you enable Backplane Autobaud in the adapter or the EDS parameter access that you set from the primary DeviceNet, the adapter only enables the Autobaud in all backplane I/O modules. When the modules listen to communications on the DeviceNet network, they detect the rate of communication and automatically set their own baudrates to match the network rate.

The module does not actually automatically detect the backplane baudrate until power is cycled or the module is reset.

TIP

Autobaud, when enabled, is useful if you swap POINT I/O modules between networks that are operating at different baudrates.



Enable Backplane Baudrate in RSNetWorx for DeviceNet.

IMPORTANT

Changes to the Backplane Autobaud parameter only take effect if they are downloaded on an individual basis (e.g., If you enable the Backplane Autobaud setting and download the change with additional changes to other features, the Backplane Baudrate remains disabled).

This parameter should be set to “Do Nothing” when you download all parameters or when Automatic Device Replacement is enabled for the adapter.

If you want to set an I/O module to use a specific baudrate (i.e., 125, 250, 500), you must first disable Autobaud for that module.

Auto Address

The EDS parameter Auto Address is available from the primary DeviceNet and lets the user sequentially order the node addresses of backplane I/O modules. This parameter is not a mode but occurs on a single occurrence only. The node address selected is assigned to the module closest to the adapter. The next closest module is assigned the next numerically higher value. The numbering pattern continues for all connected backplane I/O modules.

Enable this parameter in the RSNetWorx for DeviceNet software.

IMPORTANT

Changes to the Auto Address parameter only take effect if they are downloaded on an individual basis (e.g., If you enable the Auto Address and download the changes with additional changes to other features, the node addresses of the I/O modules remain at the previous settings).

This parameter should be set to “Do Nothing” when you download all parameters or when Automatic Device Replacement is enabled for the adapter.

Physical List Acquire Status

Physical List Acquire Status shows the status of the Physical List acquire process. The adapter maintains a Physical List that indicates the order of the node addresses of all POINT I/O modules present on the backplane.

The adapter requires that each backplane I/O module has a MAC ID greater than that of its neighbor to its immediate left. The list is created at power-up and each time a module is inserted on the backplane.

The valid values are:

- IDLE
- BUSY
- AUTO START MODE

Cycling Node Status

Using the Cycling Node Status parameter, you can easily determine the status of any POINT I/O modules with which the adapter is experiencing problems. A corresponding text string appears, including the MAC ID and a description of the status code reported in the Node Status Table. For more information on the Node Status Table, see page 2-23.

For the connection sizes mentioned below, the I/O connection sizes on DeviceNet are dependent on the scanlist configuration on the backplane.

Poll/COS Connection Consume Size

Poll/COS Connection Consume Size shows the size (number of data bytes) consumed by the poll/COS (Instance 2) I/O connection on the primary DeviceNet.

Poll Connection Produce Size

Poll Connection Produce Size shows the size (number of data bytes) produced by the polled (Instance 2) I/O connection on the primary DeviceNet.

COS/Cyclic Connection Produce Size

COS Produce Size shows the size (number of data bytes) produced by the Change of State I/O connection on the primary DeviceNet.

Strobe Connection Produce Size

The Strobe Produce Size shows the size (number of data bytes) produced by the Strobe I/O connection on the primary DeviceNet.

Cycling I/O Mapping

Cycling I/O Mapping is an EDS parameter accessible from the primary DeviceNet that shows you how data is mapped in the adapter's scanlist. The data, as shown below, is listed in order of active modules in the scanlist.

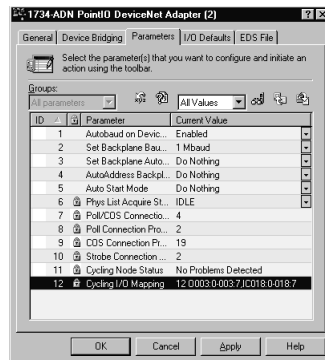

The data format is NN OBBB:b-BBB:b, IDBBB:b-BBB:b, where:

- NN = node number
- O or I = data type (output or input)
- BBB = byte number
- b = bit number
- D = DeviceNet connection (C [COS/cyclic], S [strobe], or P [poll])

IMPORTANT

If an I/O module's data has multiple mappings, you must use RSNetWorx for DeviceNet to browse to the backplane to view the mappings.

Automatic Device Replacement

With Automatic Device Replacement (ADR), the adapter automatically configures a new replacement module.

IMPORTANT

The replacement module must match the original module (i.e., same vendor I.D., device type, product code, major, and minor revision) for ADR to work. The parameters that must match are those selected in the electronic keying portion of the scanlist. The user determines the level of electronic keying.

The backplane configuration parameters (e.g., Auto Address) should be set to "Do Nothing".

The adapter is capable of holding approximately 64K of configuration data for POINT I/O modules connected to it. The adapter sends configuration data to an I/O module each time connections are created with that module (i.e., power cycle or module insertion to backplane).

You can exchange an old module for a new one if the following conditions are met:

- ADR is enabled for the adapter.
- The new module matches the old one (i.e., electronic keying).
- The new module is inserted in proper location (only for modules using the backplane).

For modules that do not use the backplane, you can exchange an old module for a new one if the following conditions are met

- The MAC ID equals 63.
- The new module matches the electronic keying of the old module.
- Only one missing module matches the electronic keying of the old module.

If the conditions listed above are met, the new module's MAC ID is changed to the appropriate value, if necessary, and the configuration information is subsequently downloaded to the module.

Physical Ordering

At start-up, or when an I/O module is inserted, the adapter detects the backplane I/O modules' order, based on MAC ID. With Physical Ordering, the adapter detects if any POINT I/O modules connected to it are out of order. If this condition is detected, the adapter changes the MAC IDs of any new modules.

IMPORTANT

If any backplane I/O modules are missing at start-up, none of the backplane modules enter run mode.

The adapter's MAC ID is always 0 on Subnet. The MAC IDs of each attached backplane I/O module must be sequentially ordered (i.e., each module's MAC ID is greater than the left adjacent module). Gaps may be left between modules.

Interscan Delay (ISD)

Interscan Delay is the time delay between consecutive I/O scans of polled devices. The default setting is 10mS. The ISD=4ms for Auto Start mode. You can change this parameter in the RSNetWorx for DeviceNet software.

The scanner uses this period of time to perform non-time-critical communications on the DeviceNet network, such as communicating with RSNetWorx for DeviceNet software. Setting this parameter to a very low value increases the latency for non-time-critical scanner operations, including the time required to respond to RSLinx software and configuration functions. Setting this parameter to a very large value reduces the freshness of the I/O data being collected by the scanner and is not advisable.

Foreground to Background Poll Ratio

Foreground to Background Poll Ratio is the ratio of foreground to background polls. You can set this parameter in the RSNetWorx for DeviceNet software.

Devices can be polled on every I/O scan (foreground) or they can be polled less frequently (background). Whether a particular device will be polled in the foreground or in the background is determined by its Poll Rate parameter on the Edit I/O Parameters dialog box, which is accessed from the Scan List property page.

The poll ratio sets the frequency of poll I/O messages to a device in relation to the number of I/O scans. For example, if the poll ratio is set to 5, the scanner will poll the selected devices once every six I/O scans. We recommend that you use a poll ratio of 1.

Expected Packet Rate

Expected Packet Rate is the rate at which the packets will be expected to be received by the scanner. You set this parameter in the RSNetWorx for DeviceNet software.

IMPORTANT

We recommend that you do **not** change the Expected Packet Rate unless you are instructed to do so by a Rockwell Automation technical support representative.

Transmit Retries

Transmit Retries are the maximum number of times that the scanner will attempt to send an I/O message to a device before it times out and generates an error message. You set this parameter in the RSNetWorx for DeviceNet software.

IMPORTANT

We recommend that you do **not** change the Transmit Retries unless you are instructed to do so by a Rockwell Automation technical support representative.

Communicating Through the Adapter

As described previously in this manual, the adapter resides on the DeviceNet network and the PointBus simultaneously. The adapter's functions are as follows:

- DeviceNet – adapter serves as a slave device that exchanges I/O data with another DeviceNet scanner device (e.g., 1771-SDN) via DeviceNet messages
- PointBus – adapter serves as master for up to 63 I/O modules, using DeviceNet messages to consume from or produce data to each module

IMPORTANT

If Automatic Device Replacement (ADR) is enabled on the adapter, you can only connect up to 62 modules via the PointBus.

For more information on ADR, see page 2-15.

Mapping Data

Your adapter must store data temporarily before transferring it between devices. You must map data to your adapter's memory before transferring it.

For a detailed description of the mapping process, see page 2-20.

Overview of the Communication Process

In a typical configuration, the adapter acts as an interface between a DeviceNet scanner (e.g., 1756-DNB) and POINT I/O modules. The example graphic below shows information transferred from a 1756-DNB to POINT I/O modules.

IMPORTANT

Although information is exchanged between the Logix5550 and 1756-DNB, this diagram (nor this chapter) is not designed to explain such an exchange.

Four data transfers are shown in the diagram, including:

1. Scanner to adapter
2. Adapter to I/O modules
3. I/O modules to adapter
4. Adapter to scanner

Key Points About Scanner to Adapter Transfer (Step 1)

1. Scanner initiates transfer
2. Scanner uses DeviceNet I/O messaging to write data to adapter. Data may contain:
 - device output data
 - configuration data

Key Points About Adapter to Output Module Transfer (Step 2)

1. Adapter initiates transfer
2. Adapter produces data for I/O module to consume. Data may contain:
 - device output data
 - configuration data

Key Points About Input Module to Adapter Transfer (Step 3)

1. Adapter consumes data I/O module has produced. Data may contain:
 - device input data
 - status data

Key Points About Adapter to Scanner Transfer (Step 4)

1. SDN consumes I/O data produced by adapter. Data may contain:
 - device input data
 - status data

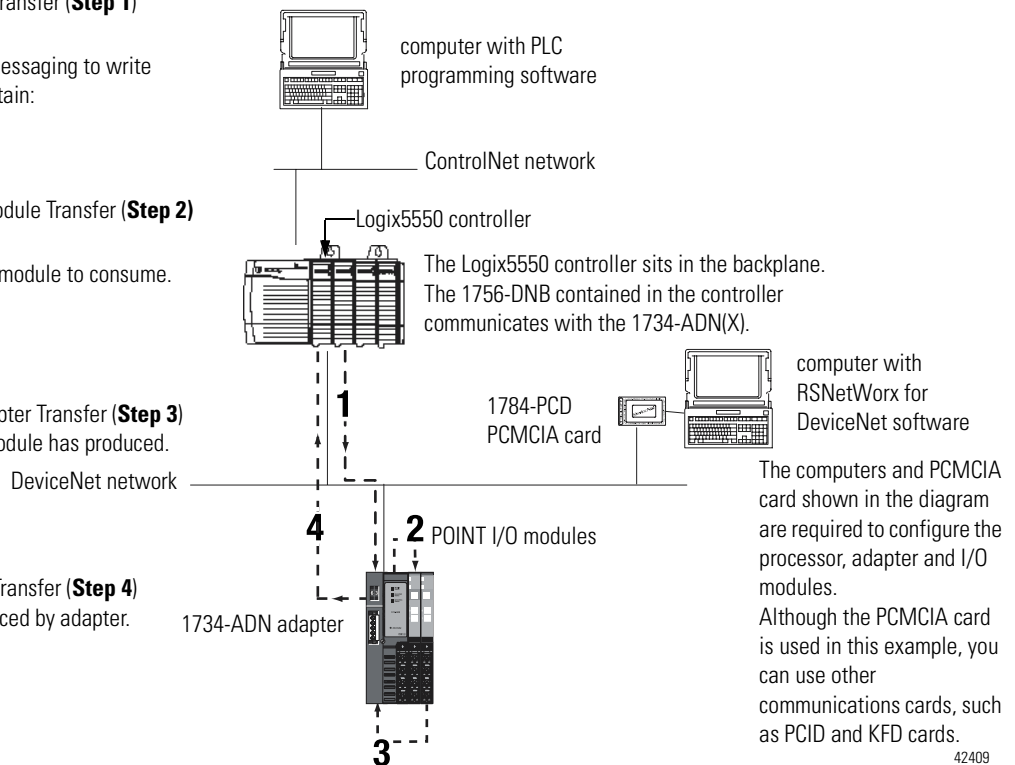

Because the adapter simultaneously resides on the DeviceNet network and on PointBus, it serves as a slave to the processor (i.e., #1 & 4) and a master to the I/O modules (i.e., #2 & 3).

The four data transfers are not necessarily sequential.

Image Table Mapping

Your adapter receives data from:

- master devices (e.g., scanners) - output data is then passed to POINT I/O modules
- input modules - input data is passed to the scanner

The adapter must map the data it receives to its internal memory before passing it to the appropriate device. The I/O map for a module is divided into:

- read bytes - input and status bytes
- write bytes - output and configuration bytes

The data is mapped by 3 buffers for input data (each representing an I/O connection on the primary DeviceNet) and 1 buffer for output data (representing data sent for Poll or COS connections on the primary DeviceNet).

The number of read bytes or write bytes can be 2 or more. The length of each I/O module's read bytes and write bytes vary in size depending on module complexity. Each I/O module supports at least 1 input byte or 1 output byte. Status and configuration are optional, depending on the module.

The graphic below shows how the adapter maps information.

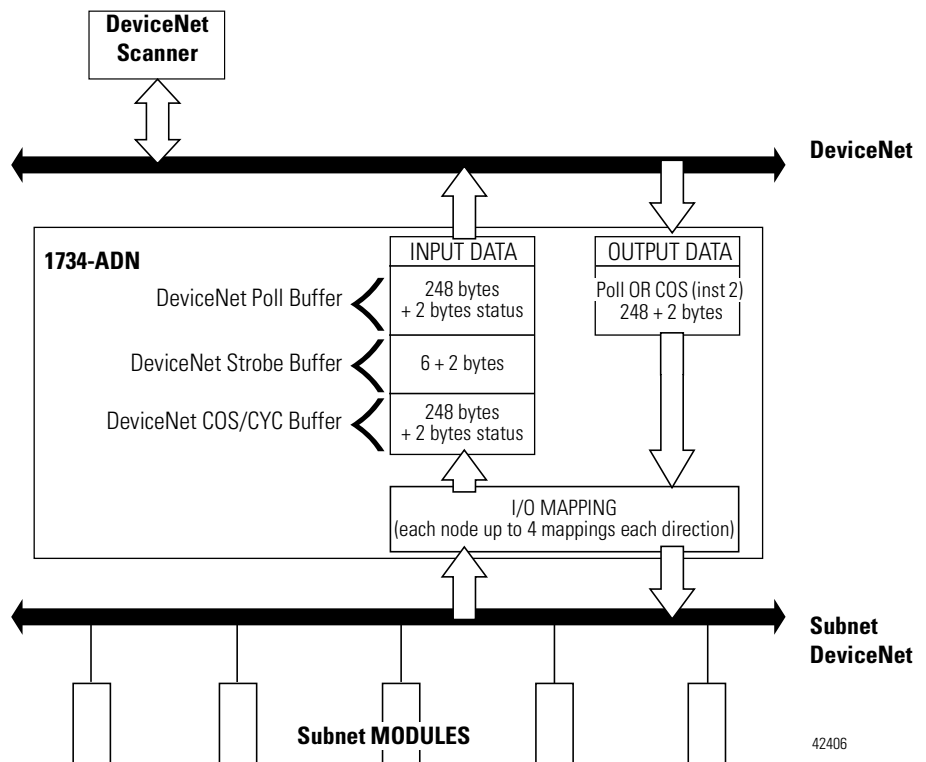

See Table 2.A for definitions of the first 2 bytes of each I/O message produced by the adapter on DeviceNet.

Table 2.A
I/O Status Word Bit Definitions

Bit	Operating Mode	Operating Mode Description	
Byte 0	0	0 = Run mode 1 = Idle mode	Run - The adapter maps output data to each module on PointBus.
	1	1 = Device failure (at least one device failed)	
	2	1 = Communication failure	Idle - Output data with zero length is sent to I/O modules.
	3	1 = Duplicate node address failure	
	4	Reserved	
	5	Reserved	Device Failure - One or more of the devices in the scan list has failed to communicate with the adapter.
	6	Reserved	
	7	Reserved	
0	Reserved		
Byte 1	1	Reserved	Communications Failure - The adapter has entered the BUSOFF state on the Subnet. Another Subnet device is configured with the wrong baud rate.
	2	Reserved	
	3	Reserved	
	4	Reserved	
	5	Reserved	
	6	Reserved	
	7	Reserved	
	0	Reserved	
1	Reserved		
2	Reserved		
3	Reserved		
4	Reserved		
5	Reserved		
6	Reserved		
7	Reserved		

The first 2 bytes of output data on the DeviceNet network that are sent to the adapter are reserved as a command word. No bits have been defined.

Communicating with I/O Modules

The adapter module supports multiple communication choices. These choices all use the default I/O structure previously described. The adapter's master (e.g., 1756-DNB) makes the actual communication choice. The choices are:

- Polled – Adapter sends data in response to received data.
- Strobe – Adapter sends data in response to the strobe command. The single bit allocated to the adapter in the strobe message is not used. If the configured size of the input data (sent from the adapter) is greater than 8 bytes, the strobe connection establishment will fail. In this case, the input size must be reconfigured to 8 bytes or less (only 6 bytes are I/O data because the first 2 bytes are the status word).
- Change of State – Adapter sends data based on detection of any changed value within the input data. Data is independently received based on change of state from the sender. Data in both directions can be acknowledged or unacknowledged depending on the run time configuration of the system.
- Cyclic – Adapter sends data cyclically based on a configured time value. Data is independently received cyclically from the sender. Data in both directions can be acknowledged or unacknowledged depending on the run time configuration of the system.

The adapter uses these messages to solicit data from or deliver data to each device. Data received from the devices (i.e., input data) is organized by the adapter and retransmitted to the master. Data received from the master (i.e., output data) is organized in the adapter and sent on to the I/O modules.

Using Diagnostic Tables

The adapter maintains three diagnostic tables to manage the flow of data between a processor and a network's devices. You can access the table over DeviceNet through the Scan Config Object (Class Code 0x90), Instance 1, via the following read-only attributes:

- **Faulted Node Table (Attribute 0xA)** - In this 8-byte table, each bit represents a node on the backplane. For example, bit 0 in byte 0 represents MAC ID 0 (the adapter), while bit 0 in byte 1 represents MAC ID 8 and so on. If a bit is set, a corresponding non-zero status value can be read from the Node State Table described below.
- **Idle Node Table (Attribute 0xB)** - In this 8-byte table, each bit also represents a node on the backplane, as with the Faulted Node Table. If a bit is set in the Idle Node Table, the corresponding node is in the scanlist and currently in idle mode.
- **Node Status Table (Attribute 0xC)** - This 64 byte table contains a status code for each possible MAC ID on the backplane. Non-zero values are accompanied with the respective bit in the Faulted Node Table being set.

See Table 2.B for an explanation of the text messages associated with the Node Status Table.

Table 2.B
Node Status Table Numeric Code Definitions

Numeric Code:	Text Message:	Definition:	Take this action:
70	DupMAC Failure	Adapter failed Duplicate Node Address check.	An I/O module has a MAC ID of zero. Change the module's address.
71	Scanner Cfg Error	Illegal data in the scan list table.	Reconfigure the scan list table and remove any illegal data.
72	Comm Failure	Slave device stopped communicating.	Inspect the I/O modules and verify connections.
73	Wrong Device Type	Device's identity information does not match electronic key in scan list table entry.	Verify that the correct device is at this node number. Make sure that the device matches the desired electronic key (vendor, product code, product type).
74	Port Overrun Error	Data overrun on port detected.	Modify your configuration and check for invalid data. Check network communication traffic.
75	Network Failure	Communication has ceased on the backplane.	Inspect the I/O modules and verify connections.
76	No Msg for Scanner	No direct network traffic for scanner detected.	No action. The scanner hears other network communication.
77	Wrong Data Size	Data size expected by the device does not match scan list entry.	Reconfigure your module for correct transmit and receive data sizes.

Table 2.B
Node Status Table Numeric Code Definitions

Numeric Code:	Text Message:	Definition:	Take this action:
78	No Such Device	Slave device in scan list table does not exist.	Add the device to the network, or delete scan list entry for that device.
79	Transmit Failure	Adapter has failed to transmit a message.	Make sure that other modules exist on the backplane.
80	In Idle Mode	Adapter is in IDLE mode.	No action necessary. If you want the adapter to run, put it in RUN mode.
82	Fragmentation Error	Error detected in sequence of fragmented I/O messages from device.	Check scan list table entry for slave device to make sure that input and output data lengths are correct. Check slave device configuration.
83	Slave Init Error	Slave device is returning error responses when scanner attempts to communicate with it.	Check accuracy of scan list table entry. Check slave device configuration. Slave device might be in another master's scan list. Reboot slave device.
84	Not Yet Initialized	Adapter is initializing the DeviceNet channel.	No action.
85	Rcv Buffer Overflow	Data size is larger than 255 bytes.	Configure the device for a smaller data size.
86	Device Went Idle	Device is producing zero length data (idle state) while channel is in Run Mode.	Check device configuration and slave node status.
89	ADR Failed	Failure occurred when downloading ADR data to the I/O module.	Reconfigure the ADR download data for the I/O module.
91	Port Bus Off	Bus-off condition detected on communications port. Scanner is detecting communications errors.	Check DeviceNet connections and physical media integrity. Check system for failed slave devices or other possible sources of network interference.
92	Port Power Off	No network power detected on communications port.	Provide network power. Make sure that scanner drop cable is providing network power to adapter communications port.

A user program can monitor the *Device Failure Bit* in the I/O message(s) received from the adapter. When it has determined the bit set, you can read the *Faulted Node Table* and *Node Status Table*, using the Explicit Message Program Control Feature of the scanner device, to determine the module experiencing problems and the nature of those problems.

Chapter Summary and What's Next

In this chapter you learned about the 1734-ADN(X) DeviceNet adapter. Move to Chapter 3 to learn about using Auto Start Mode.

Using Auto Start Mode

This chapter describes how to use the Auto Start Mode with your POINT I/O DeviceNet adapter.

For more information on:	See page:
Why Use Auto Start Mode?	3-2
Installing the Adapter	3-4
Wiring the Adapter	3-7
Installing the I/O Modules	3-8
Adding Non-Backplane Modules to Subnet (1734-ADNX Only)	3-9
Using RSNetWorx for DeviceNet	3-10
Beginning Auto Start Mode	3-11
Using Custom Configuration	3-13
Chapter Summary and What's Next	3-14

This chapter assumes you already have a DIN rail installed for your POINT I/O system. There are five simple steps to the Auto Start Mode:

1. Installing the Adapter

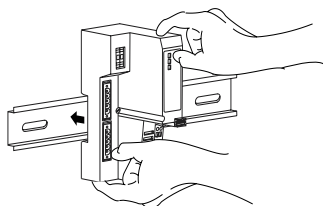

2. Wiring the Adapter



3. Installing the I/O Modules

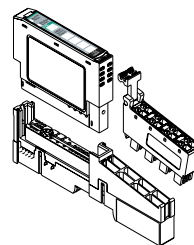

4. 1734-ADNX Only Add and Commission Non-Backplane I/O Modules to the Subnet

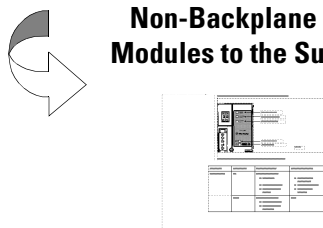

5. Using RSNetWorx for DeviceNet

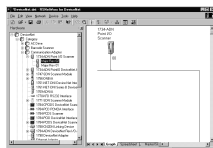

5. Beginning Auto Start Mode

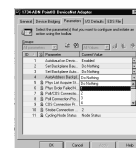

Why Use Auto Start Mode?

Auto Start Mode offers you a quick and easy method of getting your POINT I/O system 'up and running'. If your POINT I/O application can use default configuration, you should use Auto Start Mode to easily begin operations.

Once your adapter is:

- installed
- connected to the system's I/O modules
- online (in RSNetWorx for DeviceNet)

you only need to choose the Auto Start Mode option and the adapter begins working with a default configuration.

IMPORTANT

Although Auto Start Mode allows your adapter to operate with a default configuration, you can write a custom configuration after operation has begun.

For more information on how to write custom configuration for your adapter on DeviceNet, see Chapter 5, Adding the 1734-ADN(X) to the DeviceNet Scanner's Scanlist.

What Does Auto Start Mode Do?

When using Auto Start Mode, the adapter:

1. Sets all modules on the backplane to Auto Baud.
2. Reads the Subnet module's identity information.
3. Sets backplane modules' addresses sequentially.
4. Generates a scanlist for the Subnet.
5. Maps I/O data, based on byte, word, double-word, or fixed boundaries.

When this sequence of events is completed, the POINT I/O modules connected to the adapter are ready to accept connections from a scanner.

When the Adapter Uses Auto Start Mode, How Does it Map I/O Data?

In Auto Start Mode, you can map I/O data in the adapter's memory in one of the following ways:

- Byte Boundaries
- Word Boundaries
- Double Word Boundaries
- Fixed Boundaries

Byte Boundaries

Each node's I/O data is mapped in the adapter's memory at the next available byte. This option works best in applications that use Allen-Bradley PLCs and SLCs.

Word Boundaries

Each node's I/O data is mapped in the adapter's memory at the next available word. This option works best in applications that use Allen-Bradley PLCs and SLCs.

Double Word Boundaries

Each node's I/O data is mapped in the adapter's memory at the next available double word. This option works best in applications that use Allen-Bradley Logix products.

Fixed Boundaries

The map to the fixed location is based on the node address. Mapping size ranges from 1 to 32 and is set using an EDS parameter. The mapping for a node with address 1 begins on byte 2. The formula for mapping is: $2 + ((N - 1) * \text{mapsize})$, where N = node address.

- The user specifies fixed map size using EDS parameters
- Data mapped after status/channel words in I/O image, beginning with byte 2
- No data area reserved for MAC ID 0 (the adapter)

Are There Any Requirements to Using Auto Start Mode?

There are two **requirements** to using the Auto Start Mode:

- Your 1734-ADN DeviceNet adapter must use firmware revision 2.001 or higher. If your adapter does not have the required firmware, you can upgrade it with the ControlFlash tool. For more information on how to upgrade your adapter's firmware, contact your Rockwell Automation representative.
- Your 1734-ADN(X) DeviceNet adapter must be free of I/O connections on DeviceNet when you use Auto Start Mode. If another scanner device has established I/O connections with the adapter, the attempt to use Auto Start Mode is rejected. When the adapter is configuring itself in Auto Start Mode, no other device can establish I/O connections to the adapter.

Installing the Adapter

To install the adapter on the DIN rail prior to installing other base units, proceed as follows.

1. Position the adapter vertically in front of the DIN rail.
2. Press firmly to install the adapter on the DIN rail. The locking mechanism locks the adapter to the DIN rail.

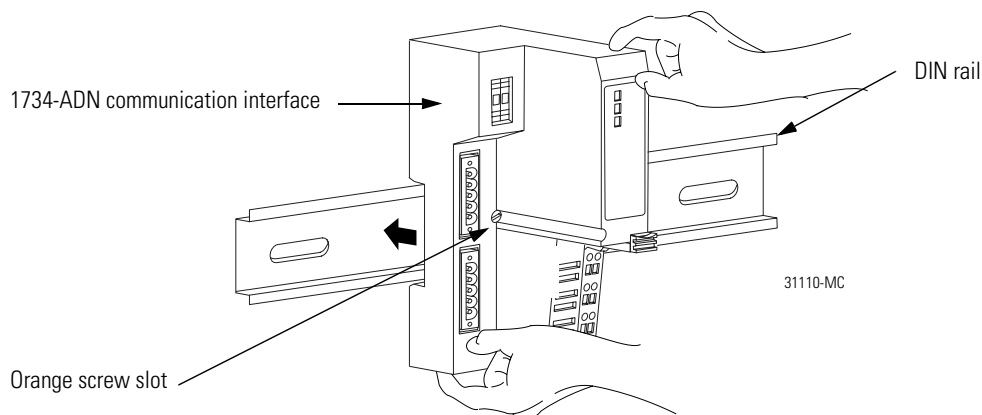

3. Insert the DeviceNet network plug and tighten the holding screws.

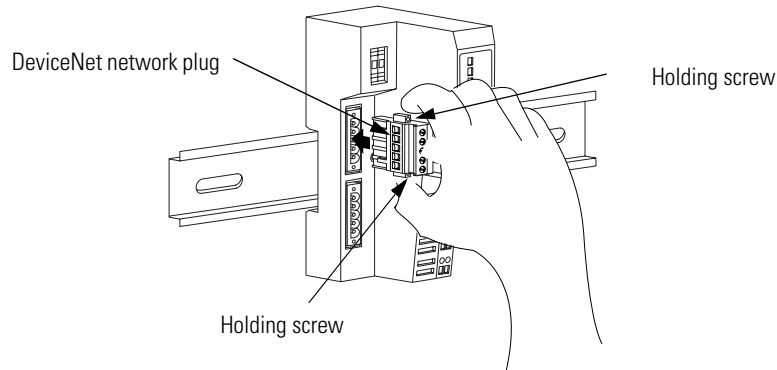

31111-MC

4. Set the node address using the 2-position thumbwheel switch. Valid physical settings range from 00 to 63 (Factory setting =63). Press either the + or - buttons to change the number.

You can also set the node address to some value between 64-99. In this case, you can change the adapter's node address via the RSNetWorx for DeviceNet software. If a value between 64-99 is used, at power-up the node address stored in the adapter's non-volatile memory is used.

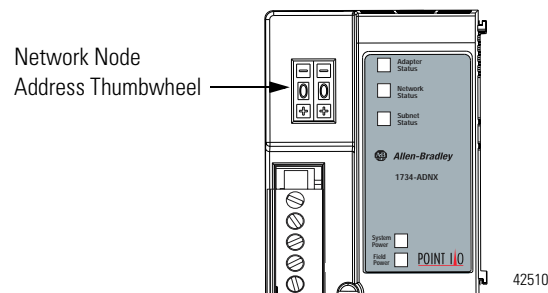

42510

5. Slide the safety end cap up to remove it. This exposes the backplane and power interconnections.

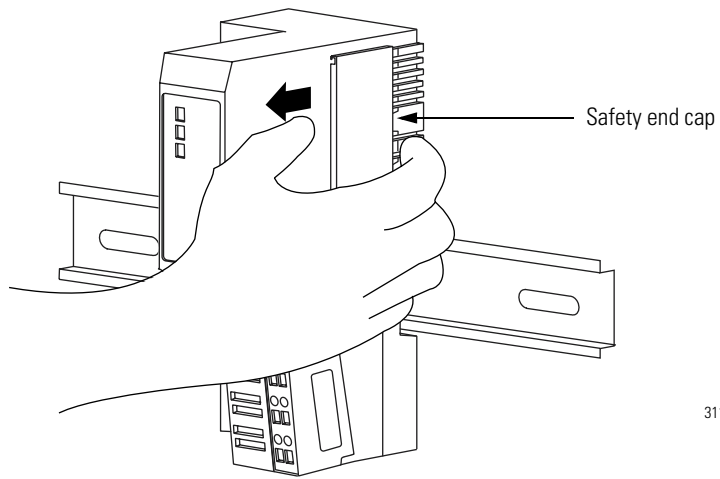

31112-MC

ATTENTION



Do not discard the safety end cap. Use this end cap to cover the exposed interconnections on the last mounting base on the DIN rail. Failure to do so could result in equipment damage or injury from electric shock.

Wiring the Adapter

Your adapter's wiring and network designations are shown below.

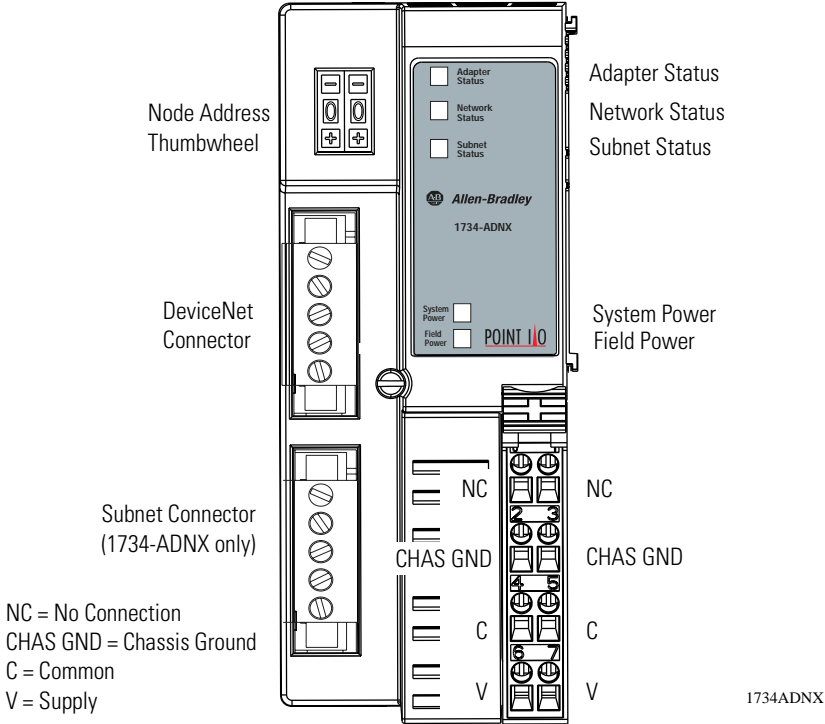

12/24V dc

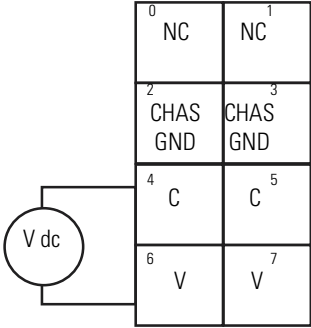

This dc supply is connected to the internal power bus.

You cannot supply power to the adapter from the DeviceNet power supply.

42513

NC = No Connection
C = Common

CHAS GND = Chassis Ground
V = Supply (Do not connect 120/240V ac power to this supply.)

Terminal		Notes
0	No connection	Reserved
1	No connection	
2	Chassis Ground	
3	Chassis Ground	
4	Common	
5	Common	
6	Voltage Input	Apply 12/24V dc. Connects to the internal power bus.
7	Voltage Input	

DeviceNet and Subnet Connector Plug Wiring

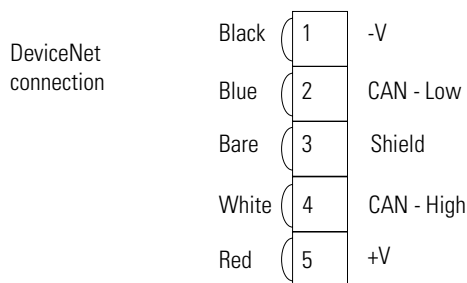

42514

Installing the I/O Modules

After installing and wiring the adapter, you should install the POINT I/O modules that will be used in your application.

For more information on installing and wiring the multiple POINT I/O modules, see the installation instructions for each catalog number or the POINT I/O Digital and Analog Modules and POINTBlock I/O Modules user manual, publication 1734-UM001.

Adding Non-Backplane Modules to Subnet (1734-ADNX Only)

The Subnet must be properly terminated. A terminating resistor (included with the 1734-ADNX) must be placed at each end of the Subnet trunk segment (see the Rockwell Automation publication DeviceNet Cable System Planning and Installation Manual, publication no. DN-6.7.2). If no cable is attached to the 1734-ADNX Subnet connector, two resistors should be attached across the blue CAN_H and white CAN_L wires, as shown below.

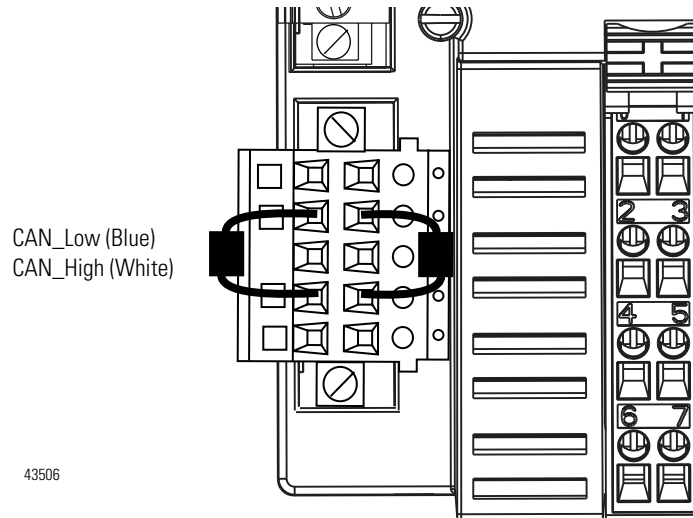

The node addresses of all non-Backplane Subnet modules must be numerically greater than the number of modules residing on the 1734-ADNX backplane.

Non-backplane modules should be configured to allow them to communicate at the desired baud rate.

If a module's configuration affects the amount of I/O data produced or consumed by that module, the desired configuration should be downloaded to the module before beginning the Auto Start Mode operation.

Using RSNetWorx for DeviceNet

You must use the RSNetWorx for DeviceNet software to configure your adapter. If using a 1734-ADNX adapter, make sure that you properly configure non-backplane modules for baudrate and MAC ID.

Follow the steps below to use Auto Start Mode.

1. Go online in the software.

IMPORTANT

Auto Start Mode is only available when RSNetWorx for DeviceNet is online.

- A. Click on the Network pull-down menu.
- B. Choose Online.

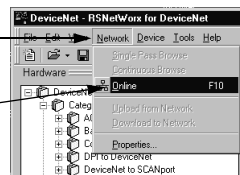

2. Browse for the primary network (e.g. You can use Single Pass Browse).

- A. Click on the Network pull-down menu.
- B. Choose a Browse type.

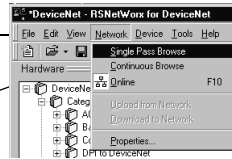

The adapter appears on the Browse screen.

3. To launch the adapter information menu, double-click on the adapter icon.

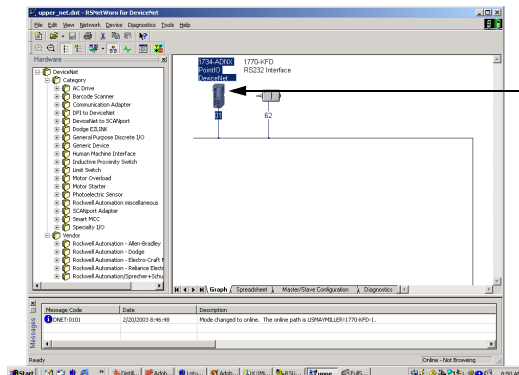

Double-click on this icon.

You can either:

- upload configuration from the device to update the software
- download configuration from the software to the device

4. Upload configuration from the device.



Beginning Auto Start Mode

1. After you upload configuration from the device to the software, you must begin Auto Start Mode.

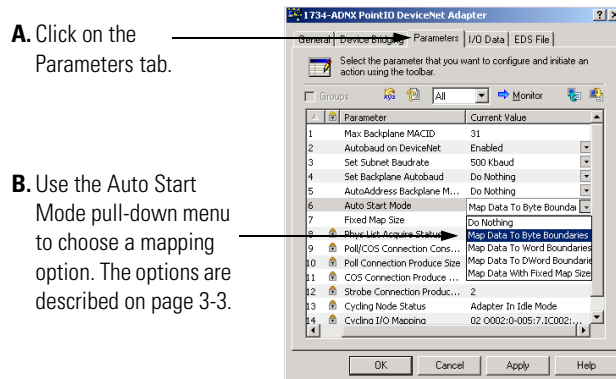

2. Download the Auto Start Mode value. Make sure you only download this Single value, as shown below.

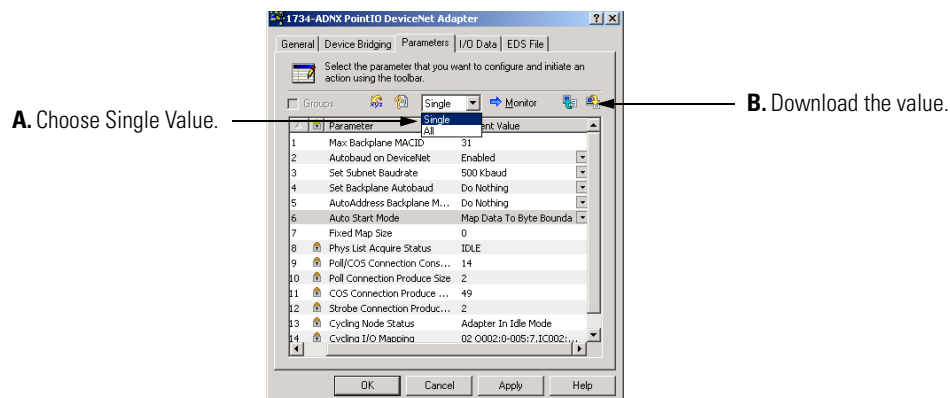

After 30-40 seconds, the adapter begins operations and uses the configuration most recently applied. During the auto start mode process, the Physical List Acquire Status field displays the words: *Auto Start Mode*, but after the download is complete the field displays the word: *Idle*.

Check for solid RED indicators on all modules

Verify that all non-backplane modules have the proper baudrate (or have autobaud enabled)

Check that MAC IDs are set to proper values

Check scanlist

- browse to Subnet and view scanlist, or look at mapping text*
- Make sure the scanlist was saved (if not, why?)*
- check ‘maximum backplane mac/id’ parameter. It should equal the number of modules residing on the backplane.*

After ASM has completed (i.e., Physical List Acquire Status field is *Idle*), verify that the operation was successful and that each I/O module was added to the adapter’s scanlist. The PointBus LED (1734-ADN) or Subnet Led (1734-ADNX) should be solid green. This indicates only that the adapter is able to establish I/O connections with each module in its scanlist, not that each module on the Subnet was successfully added to its scanlist.

To verify the presence of each module in the adapter’s scanlist, one of the following checks should be done:

- Each I/O module’s Network or Module/Network LED should be solid green. If the device has neither LED, use one of the following methods.
- By browsing to the Subnet and uploading the adapter’s scanlist using RSNetWorx for DeviceNet and verifying that the device is found in the scanlist.
- By repeatedly uploading the EDS parameter “Cycling I/O Mapping” to verify that a mapping for the concerned module exists. See page 2-15 for more information about this parameter.

If one of the following is observed, it is likely that one of the Subnet modules has been addressed incorrectly or is configured to communicate at the wrong baud rate.

- The adapter’s PointBus LED (1734-ADN) or Subnet LED (1734-ADNX) is solid or blinking red

- An I/O module's Network or Module/Network LED is solid red
- It appears that the adapter has not saved a scanlist

Use the following procedures to attempt to remedy the problem:

- Verify that each non-backplane module's address and baudrate have been set correctly.
- Verify that each backplane module is configured to autobaud. The adapter's EDS parameter 'Set Backplane Autobaud' can be used to set each module's autobaud parameter. It is necessary to cycle a module's power before the autobaud parameter change takes effect. In rare situations, it may be necessary to download the parameter and cycle power several times before each backplane module's autobaud parameter has been changed.

Note that if the adapter is configured to autobaud on the primary DeviceNet network, network traffic on the primary network is required before the backplane modules will attempt to communicate. For this reason, it is sometimes helpful to have RSLinx continuously browsing the primary network while attempting the ASM process and verification.

When it is believed that each non-backplane module is correctly configured and that each backplane module is able to communicate on the Subnet, the ASM process can be attempted again.

After successfully configuring your adapter with the Auto Start Mode feature, the adapter must still be added to the primary DeviceNet network scanner's scanlist. See Chapter 5 for more information.

Using Custom Configuration

The Auto Start Mode is recommended to quickly and easily get your POINT I/O system 'up and running'. But this mode does not prevent you from changing the adapter's default configuration after system operation has begun.

For more information on how to write custom configuration for your adapter on DeviceNet, see Chapter 4, Configuring the 1734-ADN(X) Adapter's SubNet and Chapter 5, Adding the 1734-ADN(X) to the DeviceNet Scanner's Scanlist.

IMPORTANT

Running Auto Start Mode causes the adapter's ADR configuration for the Subnet modules to be reset.

Chapter Summary and What's Next

In this chapter, you learned about the Auto Start Mode. Move on to Chapter 4, Configuring the 1734-ADN(X) Adapter's SubNet or to Chapter 5, Adding the 1734-ADN(X) to the DeviceNet Scanner's Scanlist.

Configuring the 1734-ADN(X) Adapter's SubNet

This chapter describes how to custom configure your adapter for use with POINT I/O modules.

For more information about:	See page:
Configuration Overview	4-1
Adding the Scanner to Your Network	4-2
Adding I/O Modules to Your Network	4-3
Setting the Scanner's Parameters	4-3
Going Online	4-8
Chapter Summary and What's Next	4-8

Your adapter works on two networks simultaneously and must be configured for each separately. The chapter explains configuration of the adapter for use with POINT I/O modules.

For information on how to configure the adapter for use on the DeviceNet Network see Chapter 5, Adding the 1734-ADN(X) to the DeviceNet Adapter's Scanlist.

Configuration Overview

You must use the RSNetWorx for DeviceNet software to configure your adapter. You can configure the adapter while it is:

- online
- offline

This chapter shows configuration in the offline mode. Configuration screens appear the same in both modes. The only difference is that if you make changes offline, you must take the adapter online before the configuration changes take effect.

IMPORTANT

Throughout most of this manual, we refer to the POINT I/O DeviceNet adapter (1734-ADN(X)) as the adapter. The adapter also communicates with Subnet modules as a scanner, though. In this chapter only, the adapter is referred to as a scanner.

You must follow these steps during configuration:

1. Adding the Scanner to Your Network
2. Adding I/O Modules to Your Network
3. Setting the Scanner's Parameters
4. Going Online

Adding the Scanner to Your Network

Follow these steps:

1. Start RSNetWorx for DeviceNet.
2. Add the scanner as shown below.

1. Expand the list of communication adapters.
2. Expand the 1734-ADN POINT I/O Scanner field.

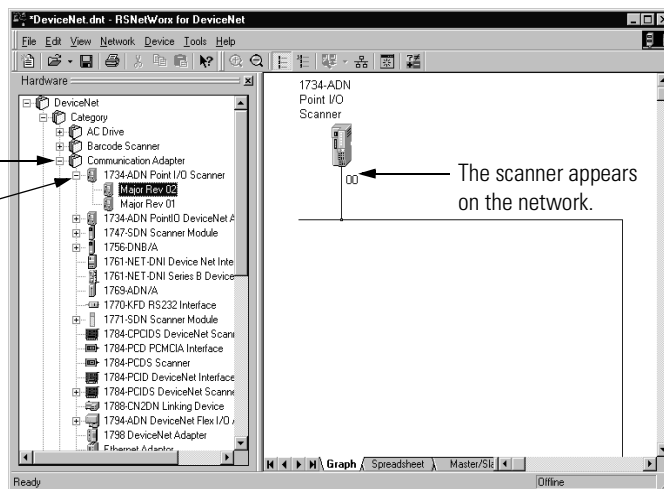

IMPORTANT

The adapter must always exist on the Subnet at Node 00.

Adding I/O Modules to Your Network

After you add the scanner, you must add the modules connected to the scanner on the Subnet. In the offline mode, I/O modules must be added individually. Follow these steps:

1. Add modules as shown below.

The screenshot shows the RSNetWorx software interface. On the left is a 'Hardware' catalog with a tree view. On the right is a network diagram showing a 1734-ADN Point I/O Scanner connected to five modules: 1734-IB2 2 Pt 24VDC Sink Input, 1734-IV4 4 Pt 24VDC Source Input, 1734-OB2E 2 Pt 24VDC Source Output, 1734-OW2 2 Pt Relay Output, and 1734-OB2E 2 Pt 24VDC Source Output.

1. Select the I/O module you want to add to the network.

2. Double-click on the catalog number to add the module.

TIP: You can also click and drag the module name onto the network.

You must configure the modules connected to the scanner. For more information on how to configure POINT I/O Digital and Analog Modules and POINTBlock I/O Modules user manual, publication 1734-UM001.

Setting the Scanner's Parameters

After adding it to the network, you must configure the scanner for use with I/O modules.

IMPORTANT This chapter shows configuration in the offline mode. Changes set in this mode do not take effect until the adapter goes online. For more information on how to go online, see page 4-8.

1. Configure the adapter as shown below.

The screenshot shows a context menu opened over the 1734-ADN Point I/O Scanner in the network diagram. The menu options include Cut, Copy, Paste, Delete, Upload from Device, Download to Device, Class Instance Editor..., and Properties....

1. Right-click on the scanner.

2. Click on Properties to configure your scanner.

TIP: You can also double-click on the scanner to view the Properties menus.

You will see a pop-up screen with a series of tabs. Each tab provides options to write configuration for your adapter. The tabs are shown below and on the following pages.

Type the scanner's name here. →

Type a description here. →

The scanner's address must = 0. →

This screen also shows the scanner's device identity. These fields are read-only. →

At any point, you can click here to finish changing configuration parameters. →

IMPORTANT: Configuration changes made in offline mode do not take effect until the scanner goes online. For more information on how the scanner goes online, see page 4-8.

Use Associate File to associate this configuration file (i.e., configuring the 1734-ADN for communication with POINT I/O modules) with the configuration file that configures the same 1734-ADN for communication with a master device on the primary DeviceNet network.

For more information on the need to maintain two configuration files in the same adapter, and the simultaneous presence of the adapter on two networks (i.e., DeviceNet as a slave and PointBus as a master), see page 5-1.

Use Clear Association to remove previously established configuration file associations that no longer apply to your adapter. →

Set the InterScan Delay here.

Set the Foreground to Background Poll Ratio here.

Click here to reset the InterScan Delay and Foreground to Background Poll Ratio back to the module default values.

Click here to change the Advanced Module Settings, as shown in the screen below.

We recommend you **DO NOT** change module settings unless advised to do so by a Rockwell Automation support representative.

Set the Expected Packet Rate here.

Set the number of Transmit Retries here.

Click here for new settings to take effect.

Add and remove I/O modules to and from the scanlist on this screen.

To set any of the parameters on this screen (e.g., Node Active) for a specific module, first highlight the module and then make specific changes.

Click here to automap I/O data when adding modules.

Click here to edit the module's I/O parameters, as shown below.

Choose electronic keying parameters for each module.

Click on the appropriate I/O data transmission method (e.g., Polled) and make changes on this screen.

Click here when finished.

Click here when finished.

Use this pull-down menu to choose a Memory type. The Memory type corresponds to an I/O connections on DeviceNet.

Highlight a module and click here to unmap it.

Click here to edit the advanced mapping parameters, as shown below.

Click here to edit the automap options, as shown below.

Set the starting byte for I/O mapping.

Set Map From parameters here.

Set Map To parameters here.

Click here when finished.

Click here to apply changes and leave the screen open.

Choose a Data Alignment and click here.

Use this pull-down menu to choose a type. This corresponds to an I/O on the primary DeviceNet.

Set the starting byte for I/O mapping here.

The bytes mapped last will determine sizes on the primary DeviceNet.

Highlight a module and click here to unmap it.

Click here to edit the advanced mapping parameters.

Click here to edit the automap options.

The Advanced and Options pop-up screens are the same for output modules as those shown for input modules. See above for an explanation of these screens.

The screens below show the remaining configuration tabs.

Use this screen to choose Automatic Device Replacement options.

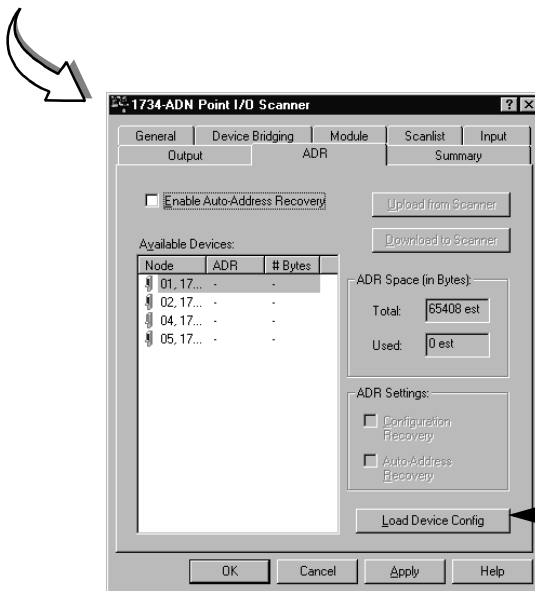

You must have loaded each device into RSNetWorx for DeviceNet before loading using this button.

You cannot change any configuration parameters on this screen. It is shown here to maintain the software's graphical integrity.

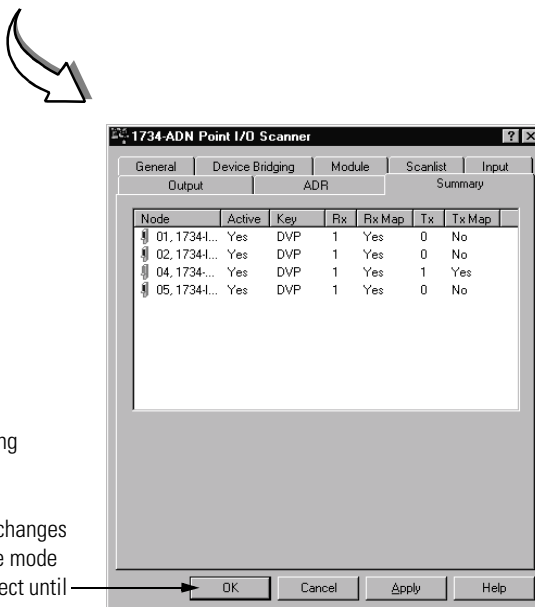

Click here when finished setting configuration parameters.

IMPORTANT: Configuration changes made in offline mode do not take effect until the scanner goes online. For more information on how the scanner goes online, see page 4-8.

This completes the configuration options. Your adapter must go online for configuration changes to take effect.

Going Online

After you set configuration parameters, your adapter must go online. Follow these steps:

1. Use the Network pull-down to go online.

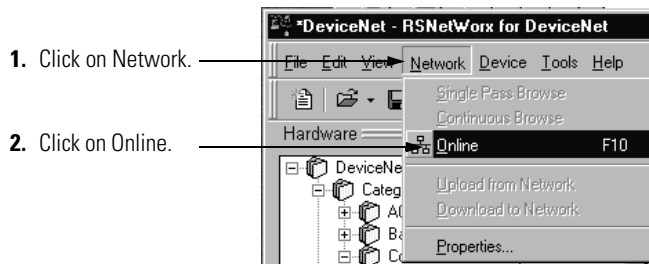

The software prompts you to save your configuration changes.

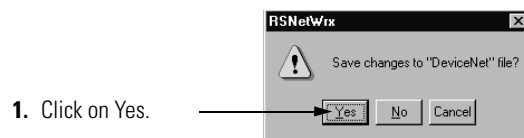

2. Choose your adapter's network as shown below.

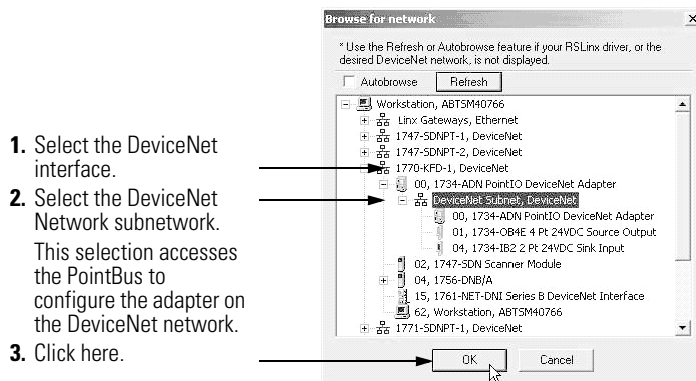

3. Apply the data to your adapter.

Chapter Summary and What's Next

In this chapter, you learned how to configure the adapter. Move to Chapter 5 to learn how to add the 1734-ADN(X) to the DeviceNet Scanner's scanlist.

Adding the 1734-ADN(X) to the DeviceNet Scanner's Scanlist

This chapter describes how to custom configure your adapter for use with DeviceNet devices.

For more information about:	See page:
Configuration Overview	5-1
Adding the Adapter to Your Network	5-2
Setting the Adapter's Parameters	5-3
Going Online	5-6
Chapter Summary and What's Next	5-6

Your adapter works on two networks simultaneously and must be configured for each separately, including separate RSNetWorx for DeviceNet software files.

This chapter explains configuration of the adapter for use on the primary DeviceNet network. For information on how to configure the adapter for use on the Subnet see Chapter 4, Configuring the 1734-ADN(X) Adapter's SubNet.

Configuration Overview

You must use the RSNetWorx for DeviceNet software to configure your adapter. You can configure the adapter while it is:

- online
- offline

This chapter shows configuration in the offline mode. Configuration screens appear the same in both modes. The only difference is that if you make changes offline, you must take the adapter online before the configuration changes take effect.

You must follow these steps during configuration:

1. Adding the Adapter to Your Network
2. Setting the Adapter's Parameters
3. Adding the DeviceNet scanner's scanlist (see the Quick Start, Appendix B)
4. Going Online

Adding the Adapter to Your Network

Follow these steps:

1. Start the RSNetWorx for DeviceNet software.
2. Add the adapter as shown below.

1. Expand the list of communication adapters.
2. Expand the 1734-ADN POINT I/O DeviceNet Adapter field.
3. You can double-click or click and drag the scanner name onto the network.

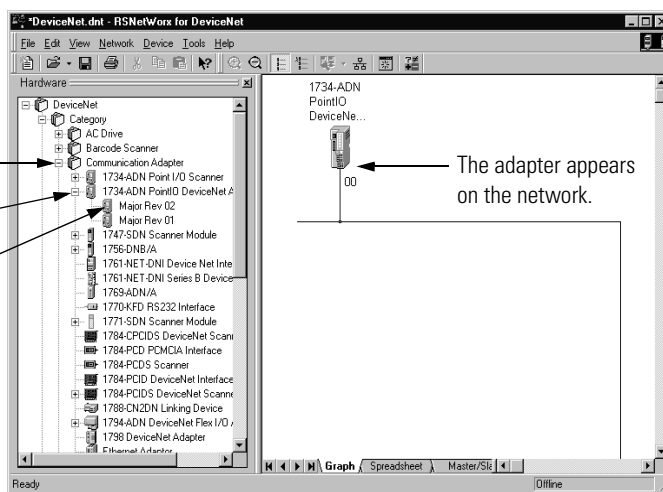

Setting the Adapter's Parameters

After adding it to the network, you must configure the adapter for use with master DeviceNet devices.

IMPORTANT

This chapter shows configuration in the offline mode. Changes set in this mode do not take effect immediately. For configuration changes to take place, you must:

- go online with your adapter
- download the new configuration to your adapter

For more information on how to go online, see page 5-6.

1. Configure the adapter as shown below.

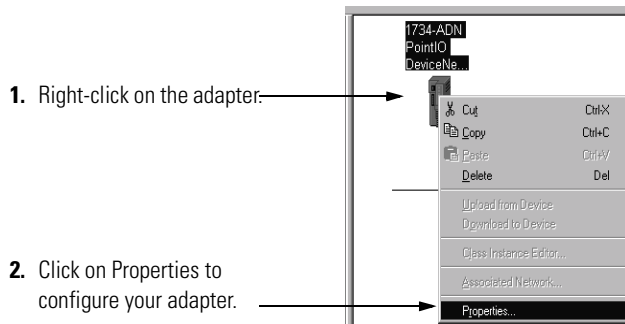

TIP: You can also double-click on the adapter to view the Properties menus.

You see a pop-up screen with a series of tabs. Each tab provides options to write configuration for your adapter. The tabs are shown below and on the following pages.

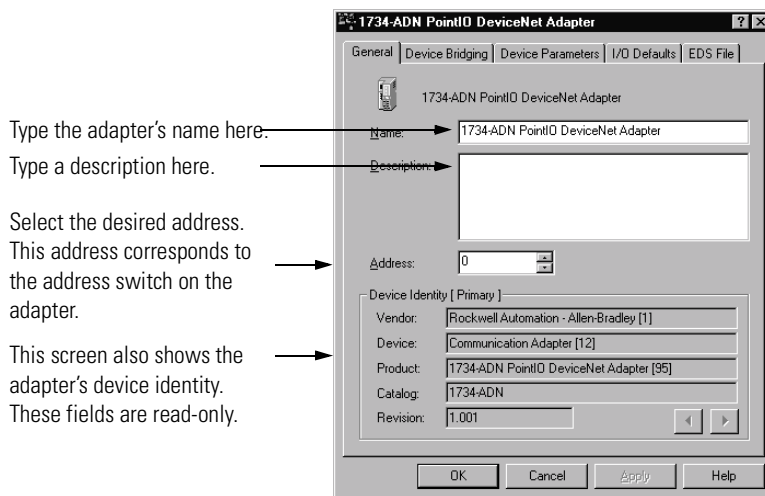

Use Associate File to associate this configuration file (i.e., configuring the 1734-ADN for communication with DeviceNet) with the configuration file that configures the same 1734-ADN for communication with POINT I/O modules.

For more information on the need to maintain two configuration files in the same adapter, and the simultaneous presence of the adapter on two networks (i.e., DeviceNet as a slave and Subnet as a master), see page 5-1.

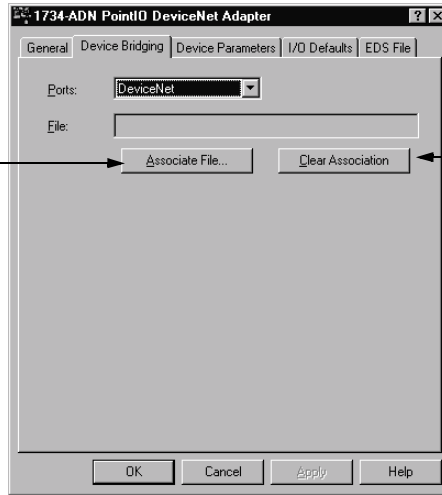

Use Clear Association to remove previously established configuration file associations that no longer apply to your adapter.

Restore all parameter default values.

For a description of a specific parameter, highlight the parameter below and click here.

Any parameter with a lock shown before it cannot be changed.

The values correspond to the I/O connection sizes from the I/O Defaults tab. They can be uploaded from an adapter with a downloaded scanlist.

The screens below show how to change the other parameters.

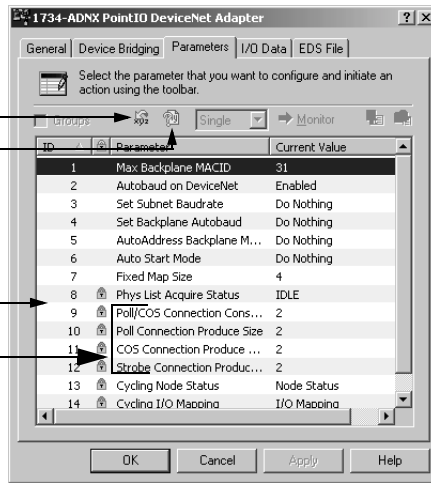

IMPORTANT: The following configuration parameters:

- Auto Start Mode
- Set Subnet Baudrate
- Set Backplane Autobaud
- AutoAddress Backplane Modules

should only be used when online and should be set to Do Nothing when Download All Parameters is selected or when saving to a scanner's ADR data.

Note:

Max Backplane MAC ID and Fixed Map Size are only 1734-ADNX configuration parameters.

Auto Start Mode



AutoAddress



Enable or disable autoaddress.

Backplane Autobaud

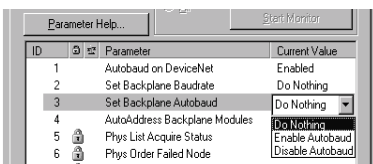

Configure backplane modules to autobaud.

Backplane Baudrate

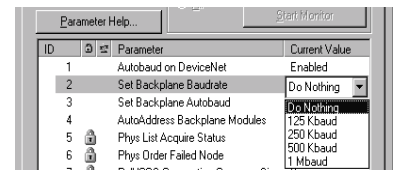

Set the backplane baudrate.

AutoAddress Backplane Modules

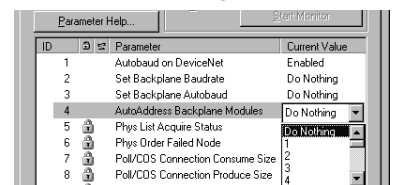

Choose the autoaddress.

The screens below show the remaining configuration tabs.

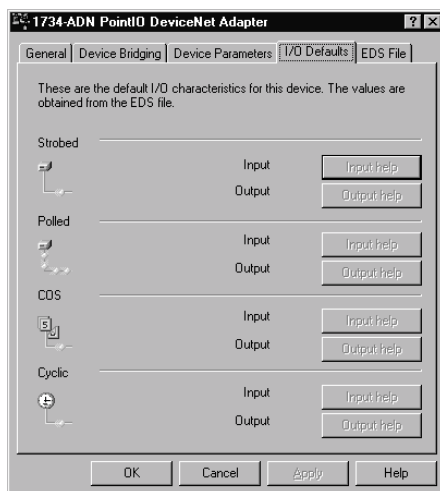

Connection sizes appear only when the Subnet network file has been associated using the Device Bridging tab.

These values correspond to the 4 parameters (Poll/COS Connection Consume Size, Poll Connection Produce Size, COS Connection Produce Size, Strobe Connection Produce Size) found on the Device Parameter's tab.

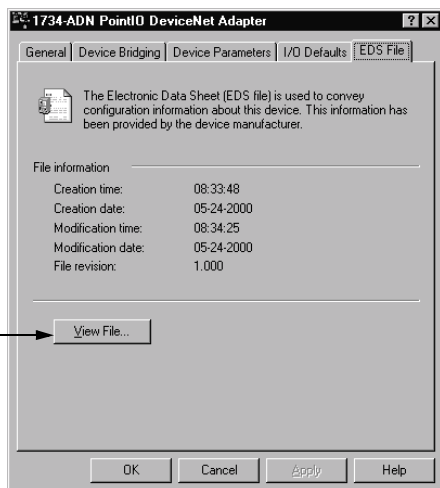

Click here to view the EDS file. An example of the EDS file is shown below.

The screen below shows an example EDS file.

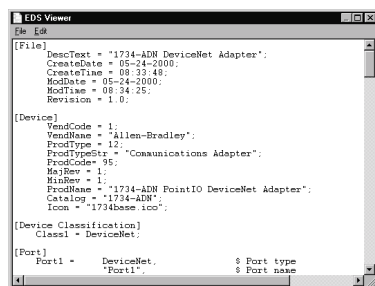

This completes the configuration options. Your adapter must go online for configuration to take effect.

Going Online

Follow these steps for the adapter to go online:

1. Use the Network pull-down.

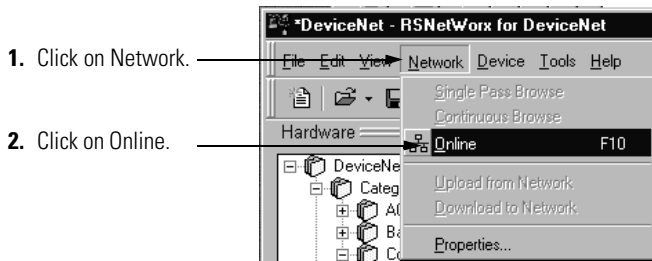

The software prompts you to save your configuration changes.

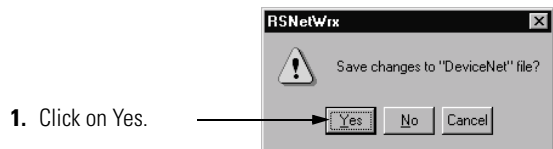

2. Choose your adapter's network as shown below.

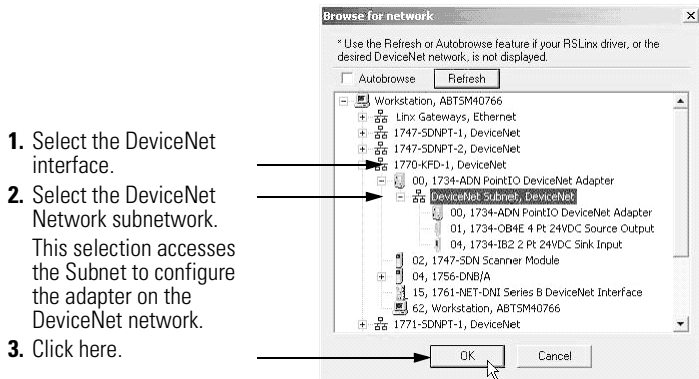

3. Apply the data to your adapter.

To learn how to add the 1734-ADN(X) to the scanner's scanlist, refer to the Quick Start section, Appendix B.

Chapter Summary and What's Next

In this chapter, you learned how to configure the adapter. Move to Chapter 6 if you need troubleshooting assistance.

Troubleshooting the 1734-ADN(X) Adapter

This chapter describes how to troubleshoot your adapter.

To learn how to:	See page:
Use the Status Indicators	6-1
Use Guidelines for Using Your Adapter	6-4
Chapter Summary and What's Next	6-4

Use the Status Indicators

You can use the status indicators to troubleshoot your adapter. The graphic below shows the adapter's status indicators.

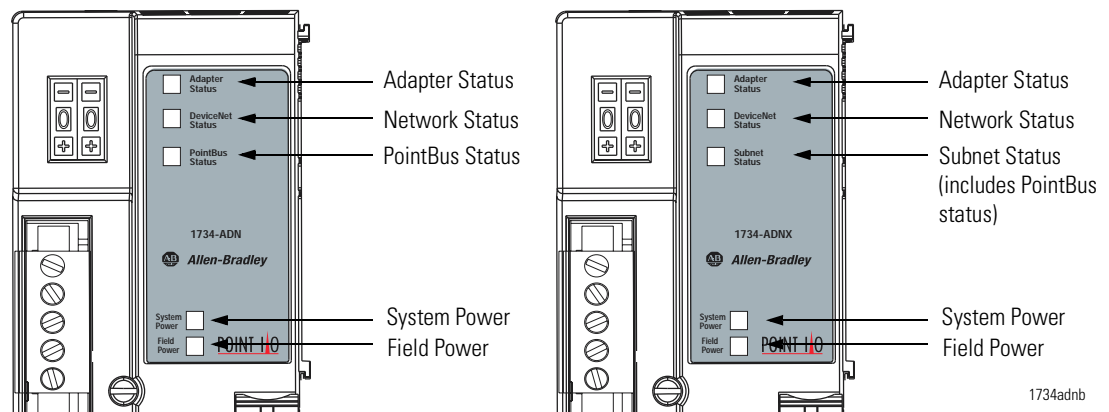

Use the table below to troubleshoot your adapter.

Indicator:	Indication:	Probable Cause:	Take This Action:
System Power	Off	Any of the following: 1. Not active 2. Field power is OFF 3. DC-DC converter problem	1. Check adapter configuration 2. Turn field power ON 3. Check DC-DC converter
	Green	Any of the following: 1. System power ON 2. DC-DC converter active (5V)	None
Field Power	Off	Any of the following: 1. Not active 2. Field power is OFF	1. Check adapter configuration 2. Turn field power ON
	Green	Power ON, 24V present	None
Adapter Status	Off	No power applied to device	Power the adapter
	Green	Device operating normally	None
	Flashing Green	Device needs to be commissioned because configuration is missing, incomplete or incorrect	Check configuration and recommission the adapter
	Flashing Red	Recoverable fault	Make sure the adapter does not need a FLASH update
	Red	Unrecoverable fault may require device replacement	Replace the adapter
	Flashing Red/Green	Device is in self-test	Wait for self-test to finish

Indicator:	Indication:	Probable Cause:	Take This Action:
Network Status	Off	Device is not online - Device is autobauding - Device has not completed dup_MAC_id test - Device not powered	Check adapter status indicator to determine if more time is needed to complete the dup_MAC_id test or if the adapter needs to be powered
	Flashing Green	Device is on-line but has no connections in the established state	None
	Green	Device on-line and has connections in the established state	None
	Flashing Red	One or more I/O connections in timed-out state	Determine the cause of the time-out. The EPR may need to be increased
	Red	Critical link failure - failed communication device. Device detected error that prevents it communicating on the network.	Make sure the device is using the correct MAC ID and baudrate
Subnet and PointBus Status	Off	Device is not on-line - Device has not completed Dup_MAC_ID test. - Device not powered - check module status indicator	Check adapter status indicator to determine if more time is needed to complete the dup_MAC_id test or if the adapter needs to be powered
	Flashing Green	Device is online but has no connections in the established state	None
	Green	Device on-line and has connections in the established state.	None
	Flashing Red	No scanlist is available. I/O module is missing.	Make sure all I/O modules are connected and using the correct MAC IDs. Check "Cycling Node Status" parameter in RSNetWorx for DeviceNet.
	Red	Critical link failure - failed communication device. Device detected error that prevents it communicating on the network.	Make sure an I/O module is not using a MAC ID =0. Make sure all backplane modules are communicating at the proper baudrate.

Guidelines for Using Your Adapter

Remember the following operational guidelines when using your 1734-ADN(X) adapter.

- Do not leave spaces in the I/O. Instead, install all POINT I/O modules adjacent to each other.

IMPORTANT

If you must leave an I/O space open temporarily, make sure you change the keying position on the mounting base (1734-MB) to #5. This position will prevent you from installing the wrong I/O module on the base.

- Populate every position on the DIN rail.
- Do not add new I/O modules to the end of the POINT I/O system while the system is under power.
- Use both labels with the I/O modules and removable terminal blocks (RTBs).
- Do not separate I/O modules and RTBs with the same number.
- Do not move I/O modules to different locations on the DIN rail after they have been installed and configured. You should always place modules with the matching RTB.
- If adjacent modules (i.e., 2 or more) are removed, replace all of them to operate the POINT I/O system. Input data will hold last state until all previously-removed modules are replaced.
- Use Allen-Bradley marker cards to identify your POINT I/O modules. The cards are easily ordered from your Rockwell Automation representative under the Bulletin 1492 number.
- Properly terminate the 1734-ADNX Subnet.
- Correctly set the Max Backplane MAC ID (1734-ADNX only).

Chapter Summary and What's Next

In this chapter you learned how to troubleshoot your adapter. Move to Appendix A to see specifications for your adapter.

Specifications

Specifications - 1734-ADN(X) DeviceNet Adapter Module

Communication Interface Specifications

Expansion I/O Capacity	<p>Up to 13 modules (13 times 75mA = 0.975, just under the limit of 1.0A). The actual number of modules can vary. Add up the current requirements of the modules you want to use to make sure they do not exceed the amperage limit of the 1734-ADN. (Note: Total expansion up to 63 modules - 13 modules maximum with 1734-ADN - add 1734-EP24DC modules for an additional 17 modules (or less based on current requirements), up to 63 module maximum)</p> <table border="1"> <thead> <tr> <th>Cat. No.</th> <th>PointBus Current Requirements</th> </tr> </thead> <tbody> <tr><td>1734-232ASC</td><td>75mA</td></tr> <tr><td>1734-485ASC</td><td>75mA</td></tr> <tr><td>1734-IB2</td><td>75mA</td></tr> <tr><td>1734-IB4</td><td>75mA</td></tr> <tr><td>1734-IV2</td><td>75mA</td></tr> <tr><td>1734-IV4</td><td>75mA</td></tr> <tr><td>1734-OB2E</td><td>75mA</td></tr> <tr><td>1734-OB2EP</td><td>75mA</td></tr> <tr><td>1734-OB4E</td><td>75mA</td></tr> <tr><td>1734-OV2E</td><td>75mA</td></tr> <tr><td>1734-OV4E</td><td>75mA</td></tr> <tr><td>1734-OW2</td><td>80mA</td></tr> <tr><td>1734-OX2</td><td>100mA</td></tr> <tr><td>1734-IE2C</td><td>75mA</td></tr> <tr><td>1734-OE2C</td><td>75mA</td></tr> <tr><td>1734-IE2V</td><td>75mA</td></tr> <tr><td>1734-OE2V</td><td>75mA</td></tr> <tr><td>1734-IA2</td><td>75mA</td></tr> <tr><td>1734-IM2</td><td>75mA</td></tr> <tr><td>1734-OA2</td><td>75mA</td></tr> <tr><td>1734-IJ2</td><td>160mA</td></tr> <tr><td>1734-IK2</td><td>160mA</td></tr> <tr><td>1734-IR2</td><td>220mA</td></tr> <tr><td>1734-SSI</td><td>110mA</td></tr> <tr><td>1734-IT2I</td><td>175mA</td></tr> <tr><td>1734-VHSC5</td><td>180mA</td></tr> <tr><td>1734-VHSC24</td><td>180mA</td></tr> </tbody> </table>	Cat. No.	PointBus Current Requirements	1734-232ASC	75mA	1734-485ASC	75mA	1734-IB2	75mA	1734-IB4	75mA	1734-IV2	75mA	1734-IV4	75mA	1734-OB2E	75mA	1734-OB2EP	75mA	1734-OB4E	75mA	1734-OV2E	75mA	1734-OV4E	75mA	1734-OW2	80mA	1734-OX2	100mA	1734-IE2C	75mA	1734-OE2C	75mA	1734-IE2V	75mA	1734-OE2V	75mA	1734-IA2	75mA	1734-IM2	75mA	1734-OA2	75mA	1734-IJ2	160mA	1734-IK2	160mA	1734-IR2	220mA	1734-SSI	110mA	1734-IT2I	175mA	1734-VHSC5	180mA	1734-VHSC24	180mA
Cat. No.	PointBus Current Requirements																																																								
1734-232ASC	75mA																																																								
1734-485ASC	75mA																																																								
1734-IB2	75mA																																																								
1734-IB4	75mA																																																								
1734-IV2	75mA																																																								
1734-IV4	75mA																																																								
1734-OB2E	75mA																																																								
1734-OB2EP	75mA																																																								
1734-OB4E	75mA																																																								
1734-OV2E	75mA																																																								
1734-OV4E	75mA																																																								
1734-OW2	80mA																																																								
1734-OX2	100mA																																																								
1734-IE2C	75mA																																																								
1734-OE2C	75mA																																																								
1734-IE2V	75mA																																																								
1734-OE2V	75mA																																																								
1734-IA2	75mA																																																								
1734-IM2	75mA																																																								
1734-OA2	75mA																																																								
1734-IJ2	160mA																																																								
1734-IK2	160mA																																																								
1734-IR2	220mA																																																								
1734-SSI	110mA																																																								
1734-IT2I	175mA																																																								
1734-VHSC5	180mA																																																								
1734-VHSC24	180mA																																																								
DeviceNet Communication Rate	<p>125K bit/s (500m maximum) 250K bit/s (250m maximum) 500K bit/s (100m maximum)</p>																																																								
DeviceNet Cable	<p>Allen-Bradley part number 1485C-P1-Cxxx Refer to publication DN-2.5 for more information</p>																																																								
Module Location	<p>Starter module - left side of 1734 system</p>																																																								

DeviceNet Power Specifications	
Power Supply	Note: In order to comply with CE Low Voltage Directives (LVD), you must use a Safety Extra Low Voltage (SELV) or a Protected Extra Low Voltage (PELV) power supply to power this adapter.
Input Voltage Rating	24V dc nominal
DeviceNet Input Voltage Range	11-25V dc DeviceNet specification
Input Overvoltage Protection	Reverse polarity protected
DeviceNet Power Requirements	24V dc (+4% = 25V dc max) @ 30mA maximum
Power Supply Specifications	
Power Supply ¹	Note: In order to comply with CE Low Voltage Directives (LVD), you must use either a NEC Class 2, a Safety Extra Low Voltage (SELV) or a Protected Extra Low Voltage (PELV) power supply to power this adapter. A SELV supply cannot exceed 30V rms, 42.4V peak or 60V dc under normal conditions and under single fault conditions. A PELV supply has the same rating and is connected to protected earth.
Input Voltage Rating	24V dc nominal 10-28.8V dc range
Field Side Power Requirements	24V dc (+20% = 28.8V dc maximum) @ 400mA maximum
Inrush Current	6A maximum for 10ms
PointBus Output Current	1A maximum @ 5V dc $\pm 5\%$ (4.75 - 5.25)
Input Overvoltage Protection	Reverse polarity protected
Interruption	Output voltage will stay within specifications when input drops out for 10ms at 10V with maximum load.
General Specifications	
Indicators	3 red/green status indicators Adapter status DeviceNet status PointBus status 2 green power supply status indicators: System Power (PointBus 5V power) Field Power (24V from field supply)
Power Consumption	8.1W maximum @ 28.8V dc
Power Dissipation	2.8W maximum @ 28.8V
Thermal Dissipation	9.5 BTU/hr maximum @ 28.8V dc
Isolation Voltage	1250V rms/V ac
Field Power Bus	
Nominal Voltage	24V dc
Supply Voltage Range	10-28.8V dc range,
Supply Current	10A maximum
1. For the 1734-ADN, DeviceNet and user supplied power (I/O power) should be powered from separate sources. For the 1734-ADNX, because there are three inputs, for CE purposes, the user supplied power must be separate from the other two (because of surge testing). DeviceNet and the Subnet can be powered from the same source.	

Dimensions Inches (Millimeters)	3.0H x 2.16W x 5.25L (76.2H x 54.9W x 133.4L)
Environmental Conditions	
Operational Temperature	-20 to 55°C (-4 to 131°F)
Storage Temperature	-40 to 85°C (-40 to 185°F)
Relative Humidity	5 to 95% noncondensing
Shock	30g peak acceleration, 11(±1)ms pulse width
Operating	50g peak acceleration, 11(±1)ms pulse width
Non-operating	Tested 5g @ 10-500Hz per IEC 68-2-6
Vibration	
Conductors Wire Size	14 AWG (2.5mm ²) - 22 AWG (0.25mm ²) solid or stranded maximum
Category	3/64 inch (1.2mm) insulation maximum 2 ¹
Terminal Base Screw Torque	5-7 pound-inches (0.5-0.6Nm)
Field Wiring Terminations	
DeviceNet	1 - Black Wire-V 2 - Blue WireCAN Low 3 - Bare WireShield 4 - White WireCAN High 5 - Red Wire+V
Power Supply	0 - No Connection 1 - No Connection 2 - Chassis Ground 3 - Chassis Ground 4 - Common 5 - Common 6 - Supply 7 - Supply
Mass	9.0 oz/255 grams
Agency Certification (when product is marked)	CE marked for all applicable directives C-Tick marked for all applicable acts DeviceNet compatible as certified by ODVA, Inc.

¹ Use this conductor category information for planning conductor routing as described in publication 1770-4.1, "Industrial Automation Wiring and Grounding Guidelines."

Notes:

1734-ADNX Quick Start

What's In This Appendix?

In this Quick Start, you will learn how to use the 1734-ADNX with a ControlLogix system on DeviceNet. You will also use one of the 1734-ADNX's features (Auto Start Mode) in an exercise to automatically configure devices on its Subnet.

When you complete this quick start you will be familiar with:

- The 1734-ADNX as an adapter on the ControlLogix primary DeviceNet network and as a scanner on the DeviceNet expansion Subnet.
- Configuring the 1734-ADNX with POINT I/O and additional devices on its Subnet.
- Using and applying the correct termination of the 1734-ADNX's Subnet.
- Using the 1734-ADNX to expand the length of a DeviceNet system
- Using the 1734-ADNX to implement a second baudrate for Subnet devices.

Assumptions

A ControlLogix DeviceNet system already exists to which you are going to add new devices without modifying the existing system's architecture. You are going to expand the length of the system beyond its maximum specification and add new devices which can operate at a different baudrate than the existing system.

The existing system attributes include:

- ControlLogix processor in a Logix chassis of 8 or more slots.
- 1756-ENBT (EtherNet/IP) in the Logix chassis.
- Configured to 125 Kbaud with thin trunk (max distance is 100m (328 ft) (ControlLogix chassis may be connected on any DeviceNet network).
- ControlLogix Processor with a 1756-DNB (DeviceNet) in slot 8 (slot 8 was picked for this example. This can be any slot.)

The new Subnet system attributes include:

- Most field devices are more than 100m from the ControlLogix Processor
- Previously installed and documented at 500 Kbaud
- 1734-ADNX with discrete inputs and outputs for several field devices
- DeviceNet Starter Auxiliary (DSA)
- DeviceNet RightSight Photoelectric Sensor
- The ability to be replicated several times in the future without changing documentation. (i.e., devices will be replicated with same attributes, node addresses, etc.)

The existing devices will be wired to POINT I/O. The DSA and RightSight will be connected to the 1734-ADNX on the 1734-ADNX's subsystem. This will allow them to run at the 500 Kbaud rate of the Subnet, at more than 100m from the ControlLogix Processor.

NetLinx will let you configure everything from your PC, using the 1756-ENBT module and a 1756-DNB. You will be able to connect from your computer over Ethernet to the ControlLogix backplane and configure both the primary (remember the 1734-ADNX will be a new node on this network) and Subnet network (the 1734-ADNX will be node 0 on this network).

When you have completed this exercise, you will be able to browse through the 1734-ADNX to see its backplane and the DSA and RightSight, using only the RSNetWorx for DeviceNet software package.

1. Open RSNetWorx for DeviceNet by double clicking the icon on your desktop.



2. From the RSNetWorx for DeviceNet main menu select **File>New**.

3. Select DeviceNet configuration.

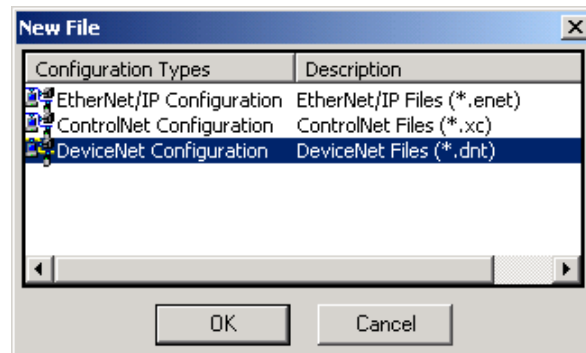

4. Click **OK**.

Now that you have created a new DeviceNet project, go online by selecting the **Online** icon on the toolbar.

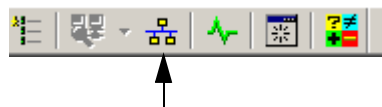

5. A list of the available drivers in RSLinx appears. Drill down from Ethernet into your ControlLogix project through the backplane to your 1756-DNB in slot 8. Select channel A, as shown below.

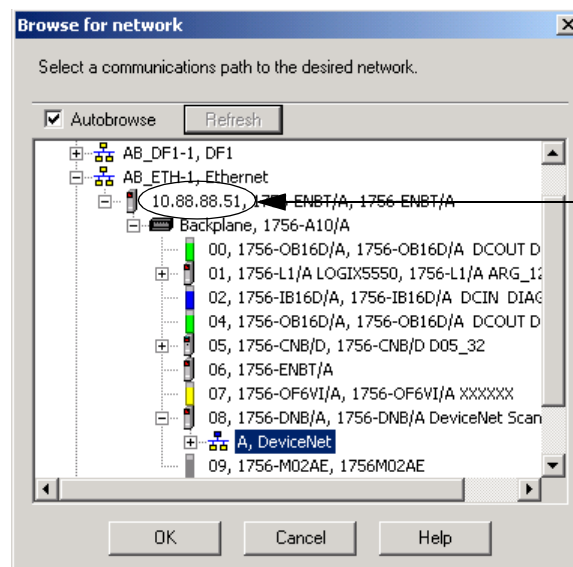

Your system may not be configured as illustrated. You must pick an Ethernet driver that is configured with the address of your ControlLogix 1756-ENBT bridge module.

The sticker on the front of your 1756-ENBT module identifies the IP address configured for your module.

6. Click **OK** to accept the path configuration.

7. Click **OK** to the prompt.

RSNetWorx will go online. A screen similar to the one below will appear:

8.  After the browse is complete, from the RSNetWorx for DeviceNet main menu select **File>Save As**.
9. Type in **MainNetwork** (use this exact name to avoid confusion later) as the filename.
10. Click **Save**.

You see a screen similar to the following:.

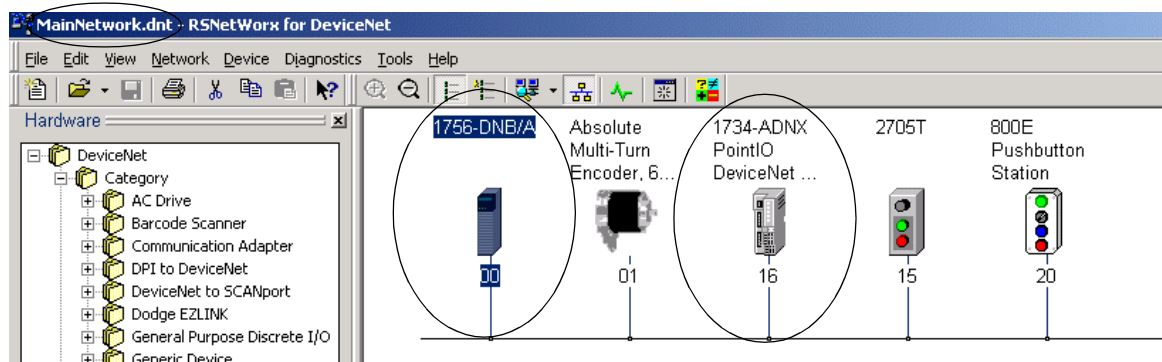

Your system may not look like the above system. (You may have more or less nodes.) It is only important to verify that you have the 1756-DNB at node 0 and the 1734-ADNX at node 16.

On the main network, the 1734-ADNX acts as an adapter.

- The dials on the front of the 1734-ADNX should be set to node 16.
 - Verify your browse reported the 1734-ADNX at node 16.
 - Later you will browse deeper to see the Subnet. (Note that on the Subnet, the 1734-ADNX acts as a scanner and is always at node 0 on that network.)
11. Download a blank scanlist to the 1756-DNB.
 - a. You do not want the existing program in our Logix processors to interfere with clearing the scanlist. To ensure that this does not occur, use the key switch to put all the processors in program mode then back to remote program (turn the keys right then back to the middle position).
 - b. Double click the 1756-DNB to bring up its properties page.

c. Select the scanlist tab and when prompted click **Download**.

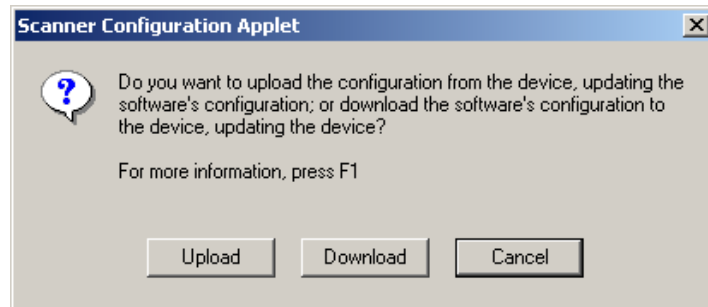

12. When the download is complete, add the 1734-ADNX to the scanlist by selecting the 1734-ADNX (node 16) and clicking the single right arrow.

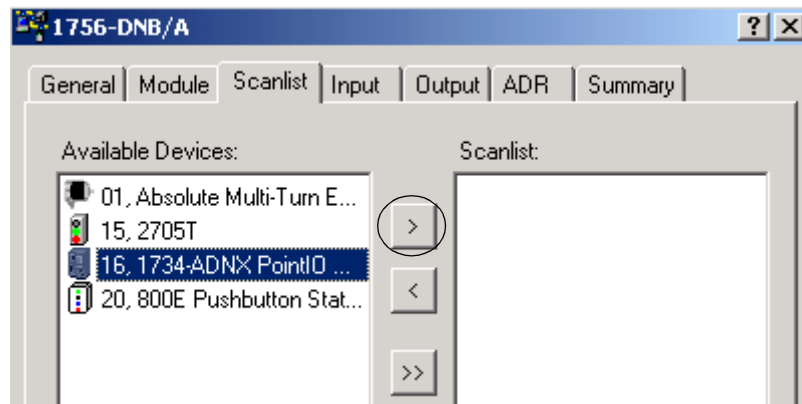

A warning window opens that says that the 1734-ADNX does not contain any I/O data.

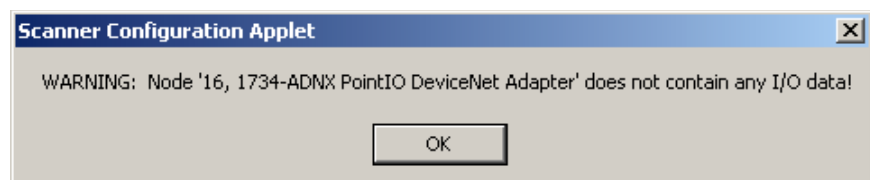

At this point, RSNetWorx for DeviceNet does not know how many bytes of data are being inputted and outputted to the Subnet so it cannot fill in the values for you.

13. Press **OK** to close the Warning window.

14. To verify that there are no data for input and outputs, click the 1734-ADNX in the Scanlist window.

15. Click **Edit I/O Parameters**.

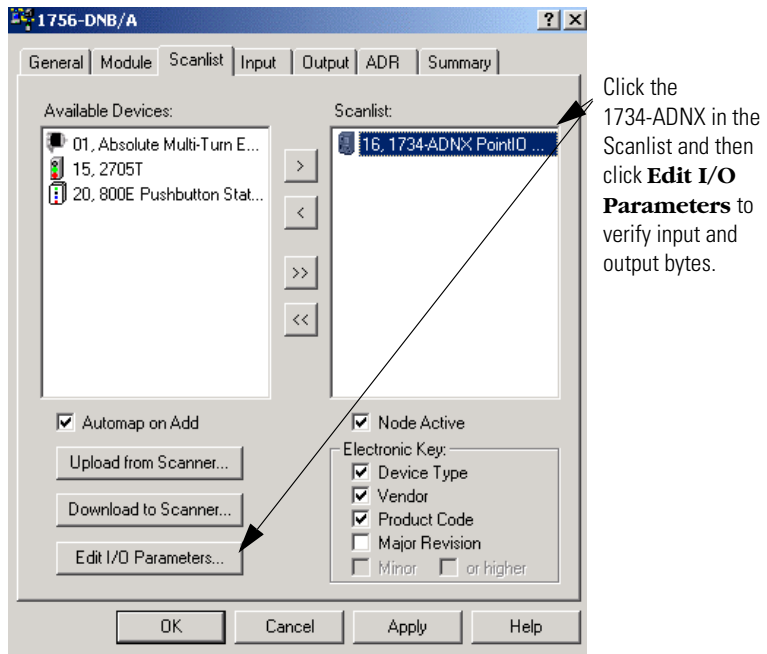

16. Verify that nothing is filled in for input and output sizes (both are zero). If you knew how much data was being produced and consumed on the Subnet, you could fill these fields in manually. Because it is easier to let RSNetWorx for DeviceNet fill in these values for us, Click **Cancel** to close this window.

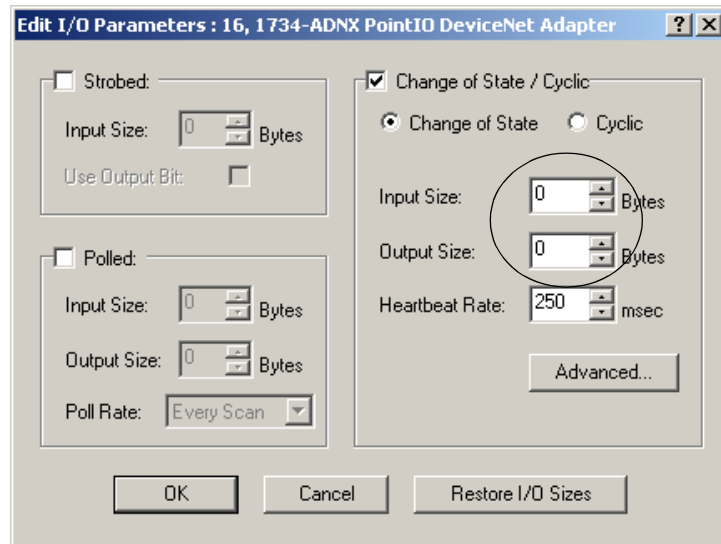

17. Remove the 1734-ADNX from the scanlist for now by clicking the double arrows.

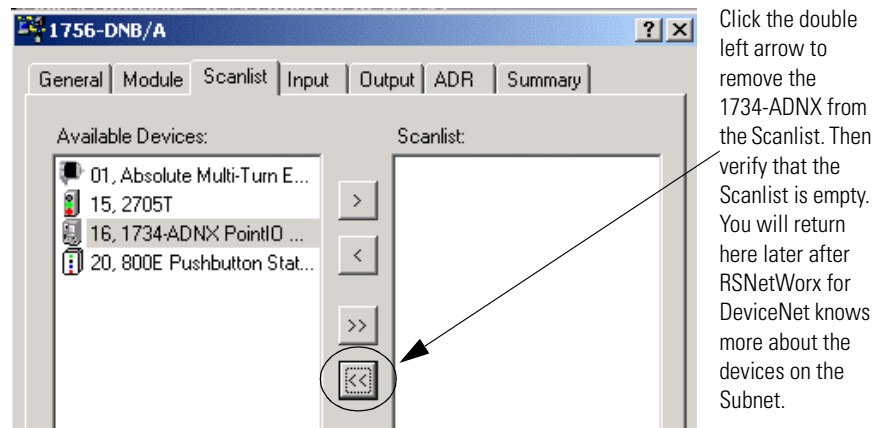

18. Click **OK**. When prompted if you want to download changes to the device, click **Yes**.

At this point you have a choice:

- You could start another instance of RSNetWorx for DeviceNet and configure the Subnet. You would then see the 1734-ADNX at node 0 on the Subnet and add the POINT I/O, DSA, and photoswitch to its scanlist. You would then map the data to the exact location you want it. For example, if someone had already written ladder logic and needed the photoswitch input at a particular address, you would map it to that address.
 - If you have not written your ladder logic yet and you are not particular about the mapping, you could use the auto start feature of the 1734-ADNX to map all the devices automatically from the primary network. After the mapping is complete, look at the Subnet to verify that everything worked as expected.
19. Verify that the subnetwork taps are electrically isolated and have their own terminating resistors at each end (4 taps: ADNX-0, DSA-20, RightSight-22, and Power with termination resistors at each end).

IMPORTANT

The Subnet must always be properly terminated. In this example there is a terminating resistor at each end of the tap string.

If you are not going to use the subnet, you must still terminate it! You can use the connector provided with the 1734-ADNX and connect two resistors between the white and blue positions.

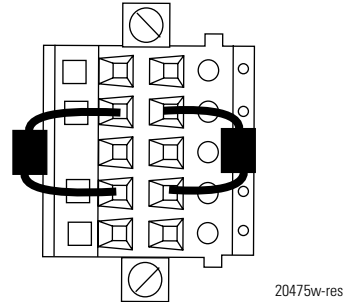

- Termination resistors are 121 Ohms, 1/4 Watt, 1%, Rockwell part number 1785A-C2.
- Do not use carbon resistors. Metal film is recommended.

Continue ONLY after You have verified that the taps are terminated correctly.

20. Double click on the 1734-ADNX to open the properties window. In the next step you will **download** the EDS defaults to the 1734-ADNX.

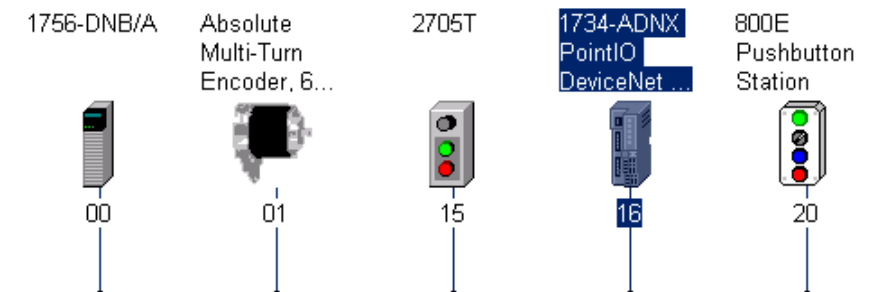

21. Select the parameter tab and choose **Download**.

22. Verify that your screen looks similar to the following screen:

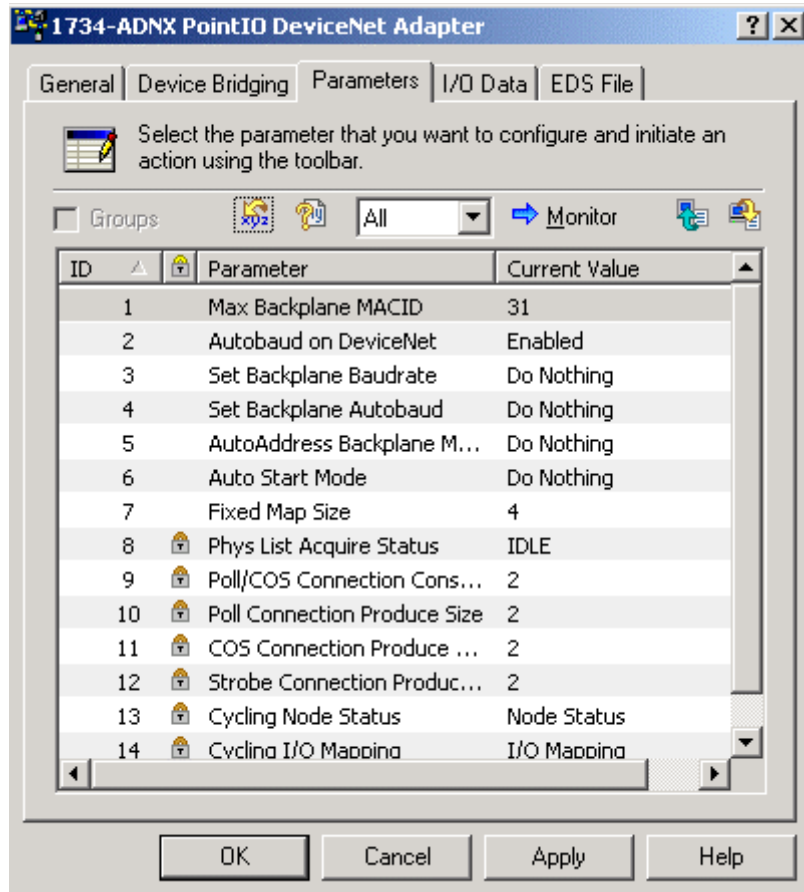

Review of the 1734-ADNX Rules and the MAC ID Parameter

To understand some of the MAC ID parameters, you should review some of the rules for using the 1734-ADNX.

- The 1734-ADNX always has address 0 on the Subnet.
- All POINT I/O backplane module MAC IDs must be numerically less than those of non-backplane Subnet modules (for our example, the POINT I/O node numbers must be less than the DSA and photoswitch).
- Each backplane module's MAC ID must be greater than that of its left neighboring module.

- A unique attribute, **Max(imum) Backplane MACID** has been added to 1734-ADNX. This value represents the highest node address of a module residing on the backplane. This value must be greater than or equal to the rightmost backplane POINT I/O module, but must be less than that of any non-backplane Subnet module. You select this value to allow for the future addition of backplane modules. The attribute's default value is 31, representing the middle of the address range (The DSA is already at a node number less than 31, so you will be required to lower this number in a later step).
- The 1734-ADNX will automatically maintain the MAC IDs of the backplane modules.
- Note that the assignment of the MAC IDs of the non-backplane Subnet modules is manual and is not performed or retained by the 1734-ADNX.
- The 1734-ADNX supports 125kb, 250kb, and 500kb baudrates. For this example, you are going to set the Subnet to 500 kb.

When using Auto Start Mode, the adapter:

- Sets all POINT I/O modules on the backplane to Auto Baud
- Reads all POINT I/O module IDs on the backplane
- Sets the POINT I/O module addresses sequentially
- Set the **Max Backplane MACID**
- Generates a scanlist for the backplane
- Maps automatically I/O data, based on **byte** (I/O data is mapped in the adapter's memory at the next available byte), **word** (I/O data is mapped at the next available word), **double-word** (I/O data is mapped at the next available double word) **boundaries** or the data is mapped to a fixed allocation size. You will choose one of these four options from a drop down menu later in this Quick Start

IMPORTANT

Your 1734-ADNX DeviceNet adapter must be free of I/O connections when you use Auto Start Mode. If another scanner device has established I/O connections with the adapter (if it is mapped in another scanner's scanlist), the attempt to use Auto Start Mode is rejected. Also, when the adapter is configuring itself in Auto Start Mode, no other device can establish I/O connections to the adapter.

When the adapter completes this sequence of events, the POINT I/O modules connected to the adapter are ready to accept connections from a scanner.

IMPORTANT

Although Auto Start Mode lets your adapter (1734-ADNX) operate with a default configuration, you can choose to manually change the configuration after operation has begun or you can write a custom configuration.

When Auto Start Mode is used, the adapter and connected I/O modules go through the following sequence of events:

- Connections are established to I/O modules
- The adapter makes Change of State (COS) connections if the I/O module supports COS, if not, the connection is Polled
- Data is mapped to the connections

The notes above explain parameter 1 – **Max Backplane MACID**. Next you will review parameter 6 and 7.

Review of Auto Start Mode

1. Select parameter 6, then click the help icon to display information about Auto Start Mode.

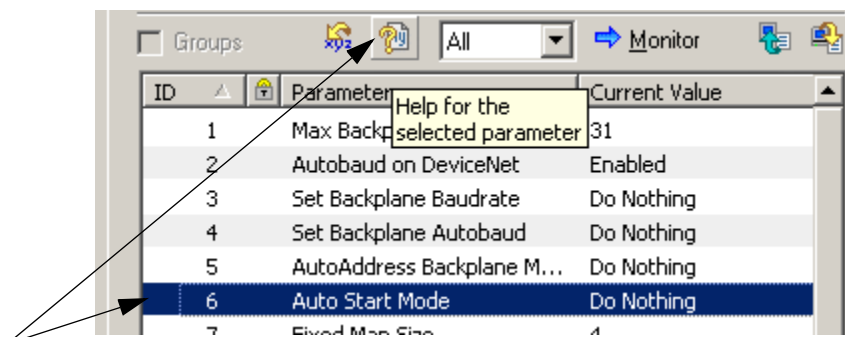

A window describing Auto Start Mode opens.

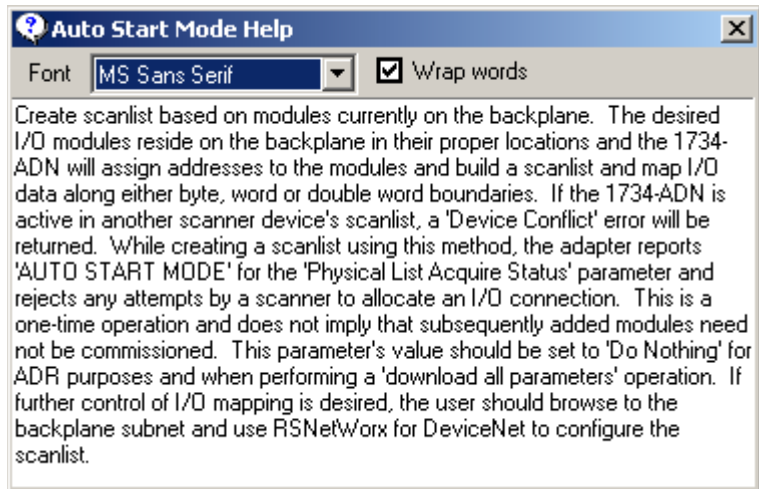

Right now, the 1734-ADNX is not in another scanner's scanlist so you can use the Auto Start Mode feature. By using Auto Start Mode, the 1734-ADNX will map all the devices on the Subnet and automatically adjust the value for parameters 1, 9, 10, 11, and 12.

2. Select the dropdown box next to **parameter 6**. You can map the data using the four options discussed earlier. If you choose to use the **Map Data with Fixed Map Size** option, the map size is selected with parameter 7.
3. For this example, choose **Map Data to Word Boundaries** as shown below:

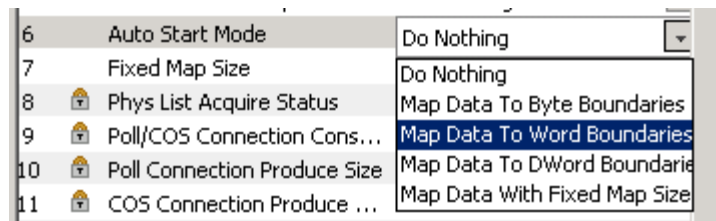

Notice that parameters 9, 10, 11 and 12 are still at their default of 2 bytes. These values will be filled out for you when this action is complete.

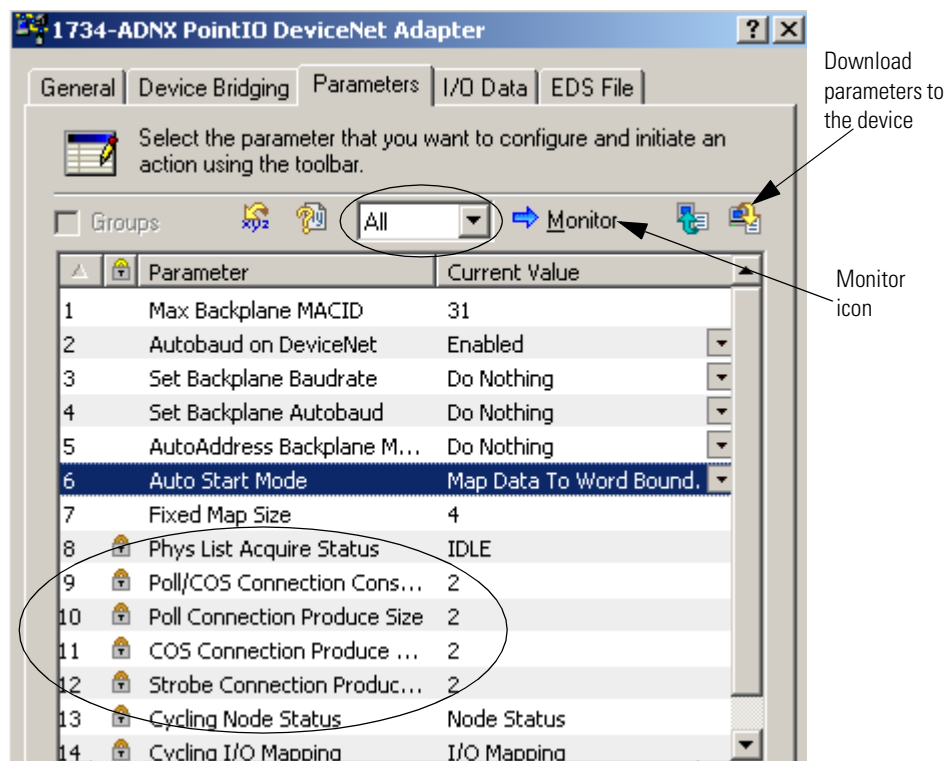

4. Make sure **All** is selected then click the icon to download parameters to the device (this triggers the Auto Start Mode).
5. Click the **Monitor** icon and notice:
 - Parameter 6 has gone back to "Do Nothing". The Auto Start has begun and will not repeat unless you trigger it again later.
 - Parameter 8 indicates you are in Auto Start Mode. Give the system at least a minute or two to complete the configuration you requested then go to the next step.

6	Auto Start Mode	Do Nothing
7	Fixed Map Size	4
8	Phys List Acquire Status	AUTO START MODE

6. Wait for parameter 8 to return to idle. Then click the **Monitor** icon to end Monitoring. Notice the following:
 - Parameter 1 has been filled in for you. There are two POINT I/O modules in the backplane, causing the default to change from 31 to 2.

- Parameter 3: **Verify the Backplane Baudrate is 500 Kbaud. If it is not, you will need to find out why and make the necessary corrections.**
- Parameter 9, 10 11 and 12 have been filled in for you.

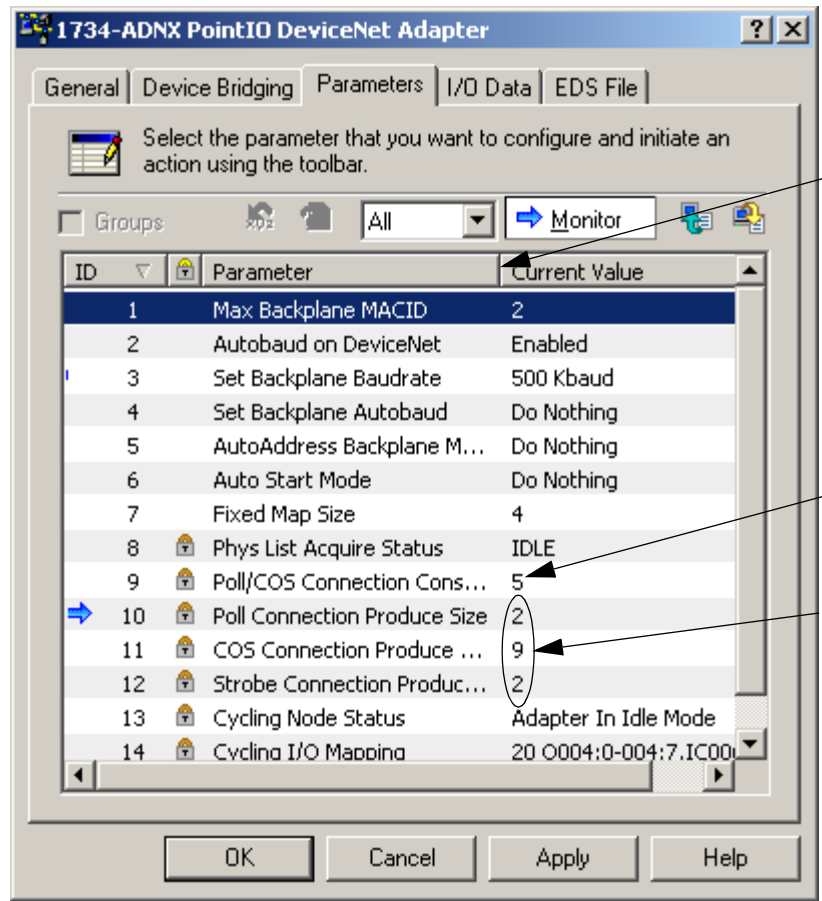



Expand the column to view all the text.

Consume size is data that the adapter will consume from the scanner. These are the outputs being sent from the scanner to the POINT I/O adapter.

Produce size is data the 1734-ADNX adapter will produce for the 1756-DNB scanner. This will be discussed in more detail later in this section.

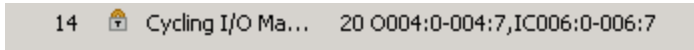
Note: You do not need to view the Subnet to determine where the data has been mapped. You can go back to monitor mode and view parameter 14. The help for this parameter states how to use the parameter to determine mapping.



7. Press **OK** to close this window.
8.  From the RSNWorx for DeviceNet main menu, select **File>Save**.

IMPORTANT You must save your work before moving on.

Browse the Subnet

Look at the Subnet at this point to make things more clear.

1. From the RSNetWorx for DeviceNet main menu, select **File>New** and then select **DeviceNet Configuration**.
2. Click **OK**.

Now that you have a new DeviceNet project created.

3. Click the **Online** icon.

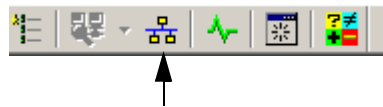

Last time you browsed to the 1756-DNB. This time you will browse a little deeper.

4. Drill down from Ethernet into your ControlLogix demo box through the backplane to your 1756-DNB in slot 8, channel A, 1734-ADNX and select DeviceNet Subnet as shown below:

Last time you browsed the **main network**

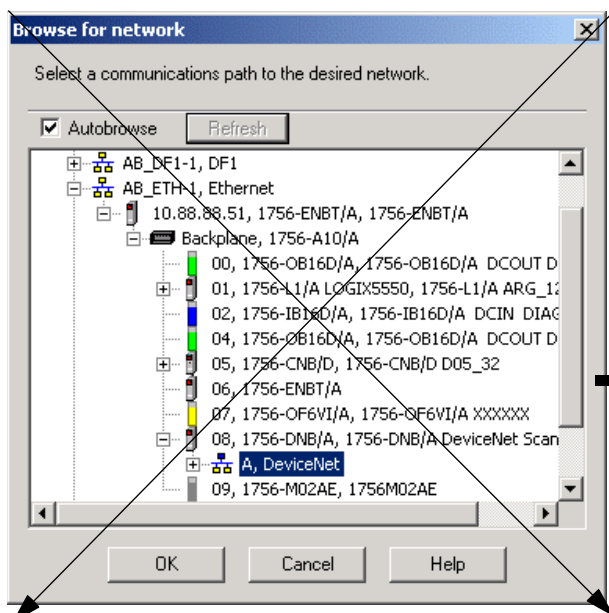

This time we will browse the **Subnet**

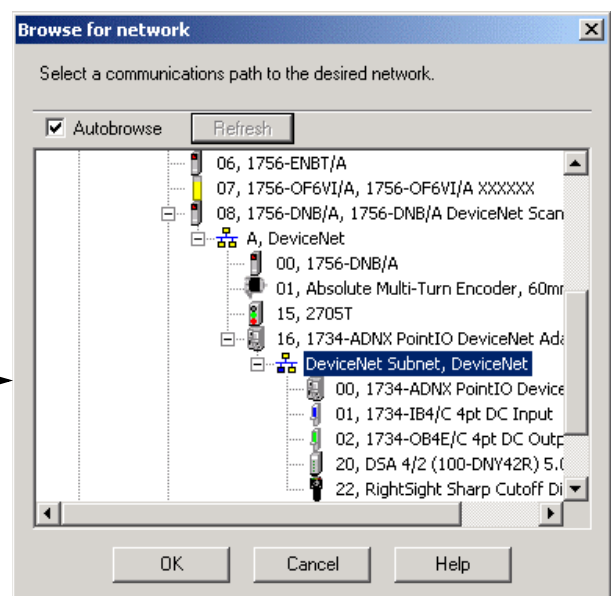

5. To go online, click **OK** to accept the path configuration and then **OK** to the prompt.

Wait for the browse to complete.

6.  From the RSNetWorx for DeviceNet main menu, select **File>Save As**.
7. Type in **SubNet** as the filename.
8. Click **Save**.

IMPORTANT You must save your work before continuing.

9. Verify your screen appears as shown below.

The nodes can be in any order. Verify:

- All five are there
- They have the correct node numbers

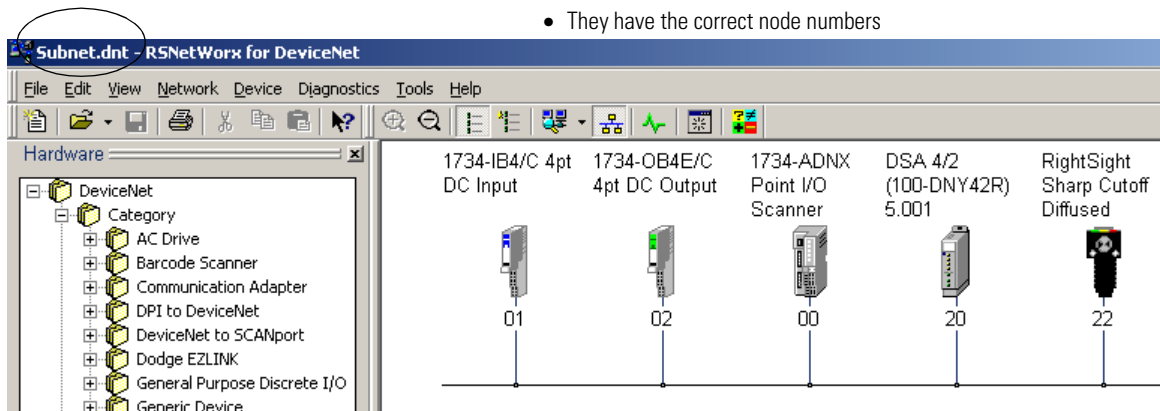

On the Subnet, the 1734-ADNX is a scanner and it is always at node 0. It is OK for some or all of the node numbers on the Subnet to be the same as devices on the primary network. Because they are two different networks, duplicate node errors will not occur. The 1734-ADNX will communicate back to the 1756-DNB scanner as a single entity (only taking up one node number on the main network).

10. To view the configuration you just created, **Upload** the scanlist from the 1734-ADNX. Double click on the 1734-ADNX to bring up its properties page.
11. Select the scanlist tab and when prompted select **Upload**.

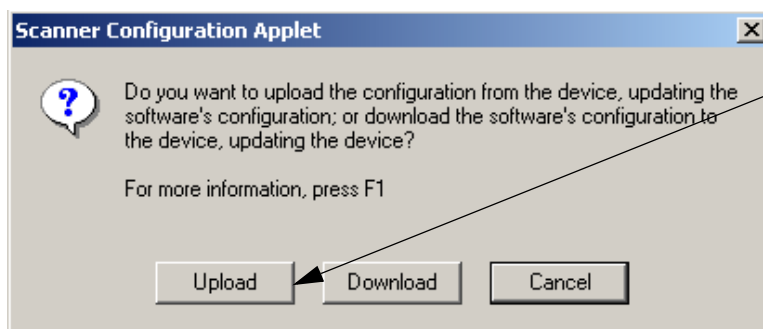

Make sure you click **Upload!** You do not want to download over the configuration you just created.

12. When the upload is complete, select the scanlist tab.
 - Verify your scanlist matches that shown below.

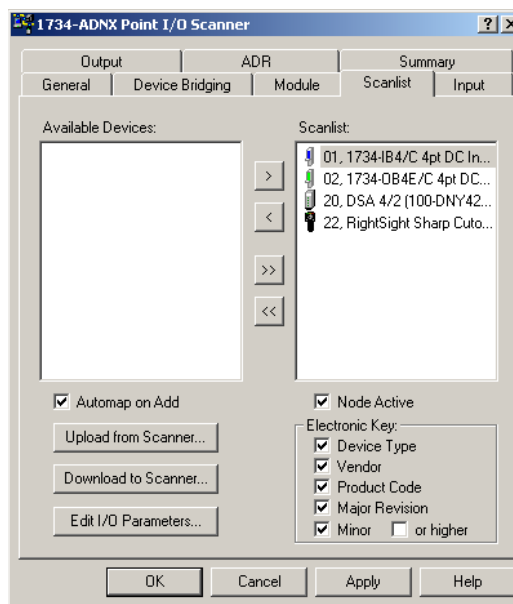

- Notice that all the POINT I/O, the DSA, and the RightSight have been added to the scanlist as you probably expected.

You are about to look at the input and output tabs. Based on your selections earlier, all the data should be mapped to word boundaries.

Inputs and Outputs

1. Select the **Input** tab. A single word is 16 bits. Notice that the mapping is as expected.
 - The first two bytes (1 byte = 8 bits) are reserved as read only.
 - The first word is completely used, so the 1734-IB4 can map to the beginning of the next word (Byte 2, bit 0).
 - There is a space between the 1734-IB4 and the 1734-OB4E because the next word does not start until Byte 4. The same is true for the DSA and the RightSight.

The screenshot shows the '1734-ADNX Point I/O Scanner' window with the 'Input' tab selected. The 'Module' sub-tab is active, displaying a list of modules and their mappings. The 'Memory' dropdown is set to 'Cos/Cyclic' and 'Start Byte' is 0. The bit mapping table shows bits 0-1 as Read-Only, bit 2 as '01, 1734-IB4/C 4pt DC Input', bit 4 as '02, 1734-OB4E/C 4pt DC Output', bit 6 as '20, DSA 4/2 (100-DNY42R) 5.001', and bit 8 as '22, RightSight Sharp Cutoff Diffused'.

This field describes how the data is transferred between the I/O modules and the adapter on the PointBus Subnet.

The current memory buffer selected is COS/Cyclic. There are also buffers for Polled and Strobed. This is how the data will be transferred to the scanner (1756-DNB in this example).

Note the mapping in the 1734-ADNX Scanner is shown in byte increments. The 1756-DNB displays in double words (4 bytes).

Use the scroll bar as needed to see all of the data.

The first 2 bytes are reserved for status.

Scroll down and notice that bytes 0 through 8 = **9 bytes total** were enough for the input data.

Bits 7 - 0	7	6	5	4	3	2	1	0
5								
6	20, DSA 4/2 (100-DNY42R) 5.001							
7								
8	22, RightSight Sharp Cutoff Diffused							
9								

This matches what you observed earlier on the main network:

Earlier view of the parameters.

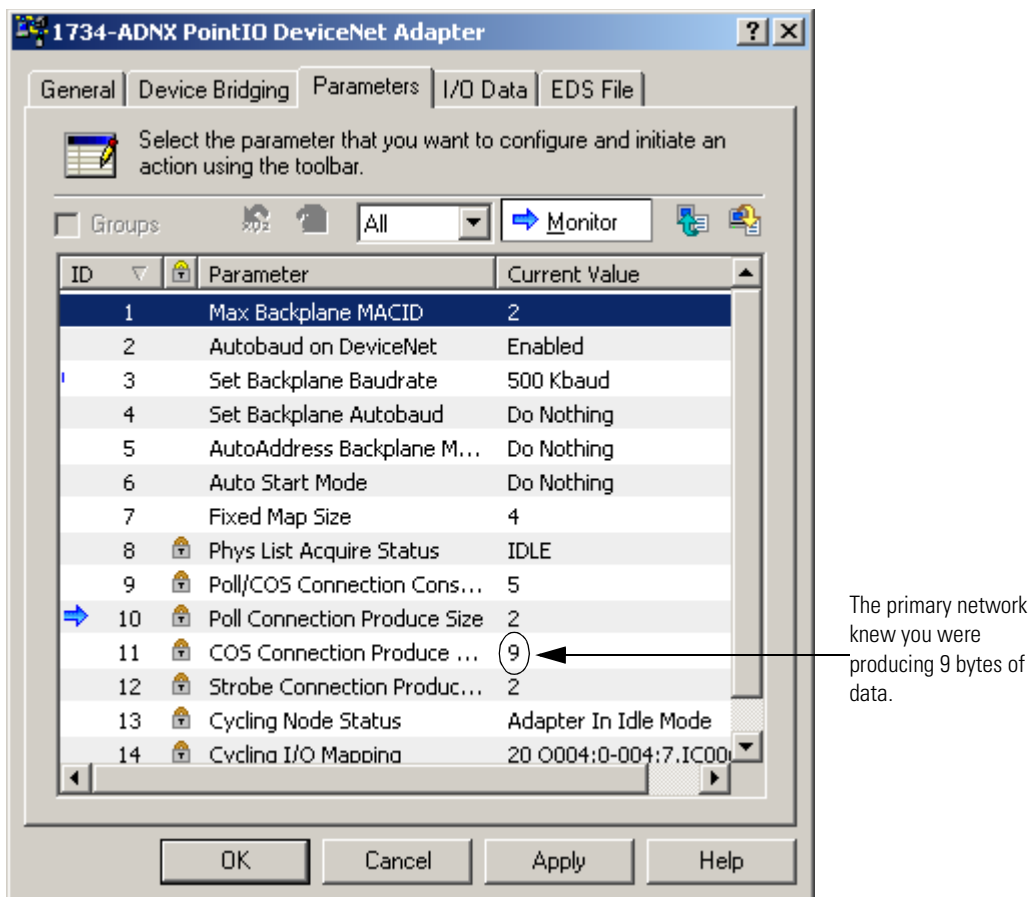

- The data mapped in the 1734-ADNX will be exchanged with the 1756-DNB scanner.
 - There are three memory buffers that the 1734-ADNX uses for input data to the scanner on DeviceNet. The buffers are Cos/Cyclic, Polled, and Strobed. You can map data into any of the three buffer areas on the adapter.
 - Currently, all of the I/O modules are mapped to the Cos/Cyclic buffer.
2. Select the dropdown listbox next to the **Memory** label in the middle of the window to display the three memory buffer choices.
 3. Select each of the choices and view the mapping. You will see that only the Cos/Cyclic buffer is being used (There are 2 bytes reserved for status in each buffer. These words are not for a specific module.)
 4. Set the **Memory** selection back to Cos/Cyclic.

Note that for the 1734-ADNX, each line in the mapping area represents a byte of data. When you view the 1756-DNB, each line will be 4 bytes of data (double word).

Now you are ready to take a look at the output side. Based on the numbers you saw on the main network you expect to see 5 bytes (two of them are going to be reserved status words).

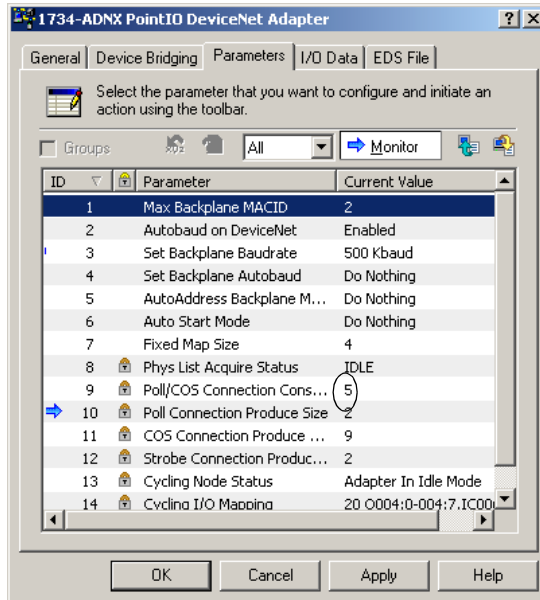

Earlier view of the parameters.

You should still be looking at the subnet 1734-ADNX **Input** tab. Now select the **Output** tab and verify you have the following:

- Notice the RightSight does not appear.
 - It is an input to the scanner - reporting if an object is detected.
 - It does not have any outputs.
- The DSA has both inputs and outputs.

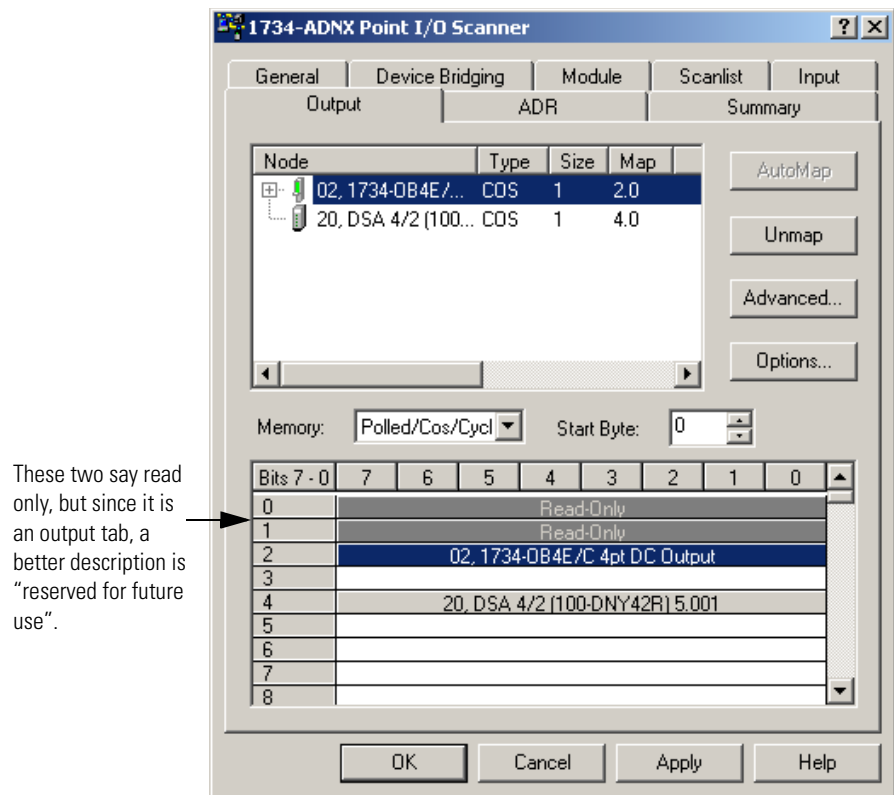

5. Expand the plus next to node 2.

- Several revs ago (RSNetWorx for DeviceNet V3.21) the ability to view I/O Details from the Input and Output property pages was added into the software.
- From the Input and Output property pages, you can view detailed I/O information for each device in the scanlist of a DeviceNet scanner.
- To view the I/O details for a particular device, click the plus sign (+) located to the left of the device. If a plus sign (+) is not displayed, there are not any I/O details for that device.
- This feature is driven by each device's EDS file.

6. Select Output Value #1 and notice the exact location of that bit is displayed. You can easily tell that Output Value #1 is in Byte 2, Bit 1. This information will make it very easy to write your ladder logic later.

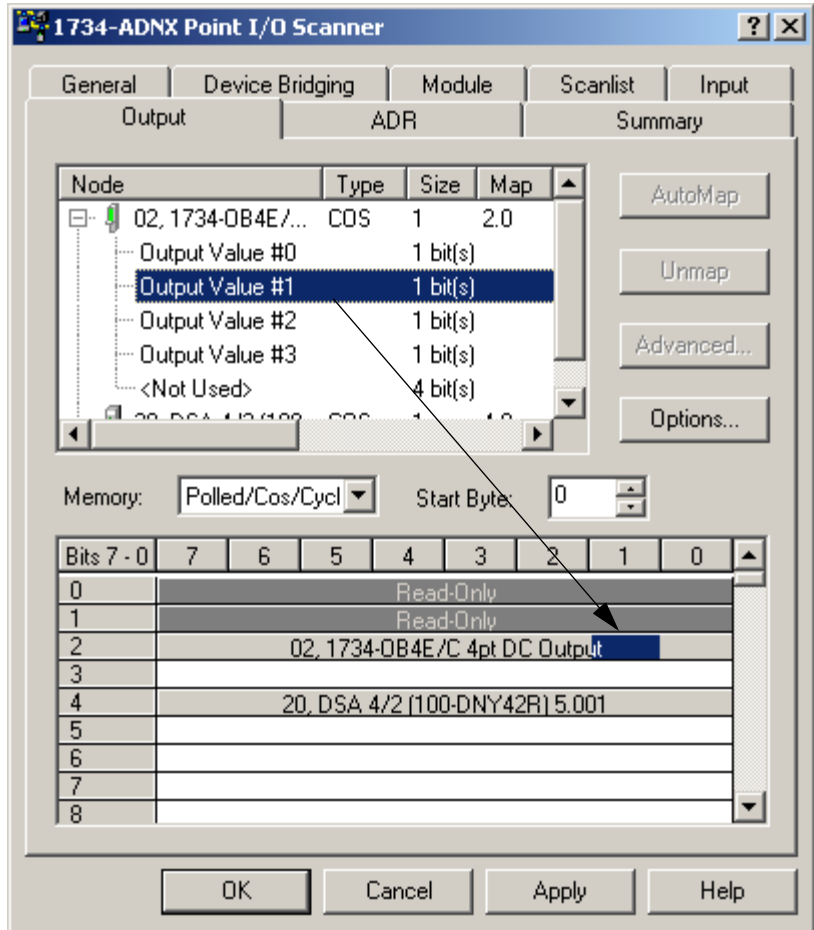

You uploaded the scanlist and looked at the Input and Output data. Now you are about to save this information to your hard disk.

7. Click **OK** (not cancel) to close this window.

Click **OK** and not **Cancel** to close the window.

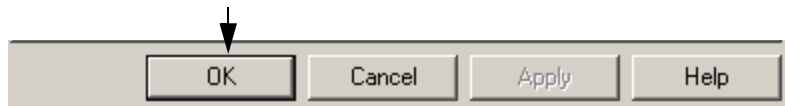

8.  From the RSNetWorx for DeviceNet main menu, select **File>Save**.

IMPORTANT

You must save your work before moving on.

Now all the information is saved in the file **Subnet.dnt**.

Navigate Between Networks

A nice feature of RSNetWorx for DeviceNet is the easy way it lets you commission the Subnet. You can have two DeviceNet projects because there are actually two DeviceNet networks. Another nice feature of RSNetWorx for DeviceNet is the easy way it lets you navigate between two related networks rather than having to keep track of which network file goes with what.

RSNetWorx for DeviceNet provides an easy way to associate two networks that will allow quick navigation between them. You will look at that now.

1. Double click on the 1734-ADNX icon to pull up its properties page.

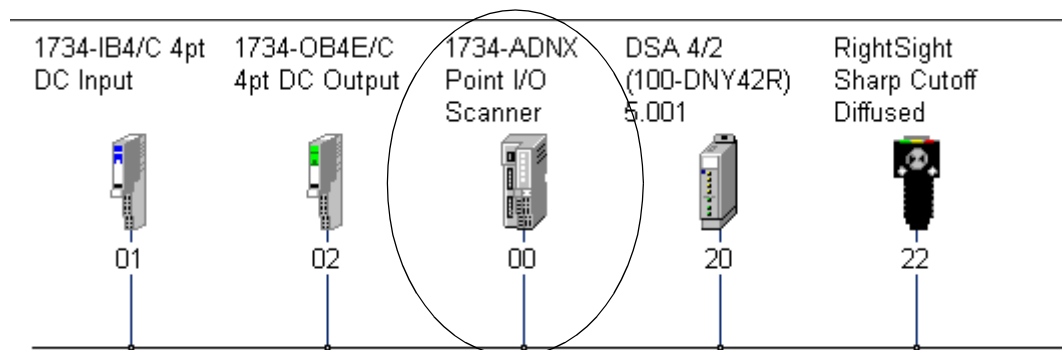

2. Select the **Device Bridging** tab. The following window opens.

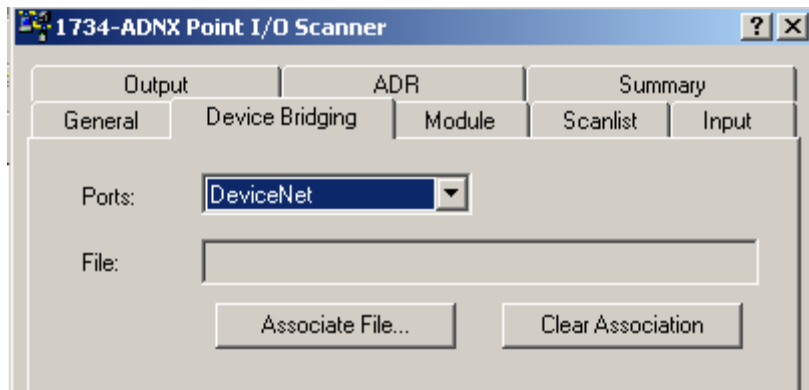

This window lets you define a file that is “associated” with this one through the 1734-ADNX. Once you specify the associated file, you will be able to jump to that file through a menu selection from the 1734-ADNX. The file you need to associate in this case is the **MainNetwork.dnt** project file you created earlier.

3. Click the **Associate File** button.
4. Make sure you are looking in the **Networks** folder in the path shown below.

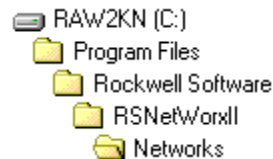

5. Select **MainNetwork.dnt** then the **Open** button. The MainNetwork.dnt file will appear in the **File** box as shown below.

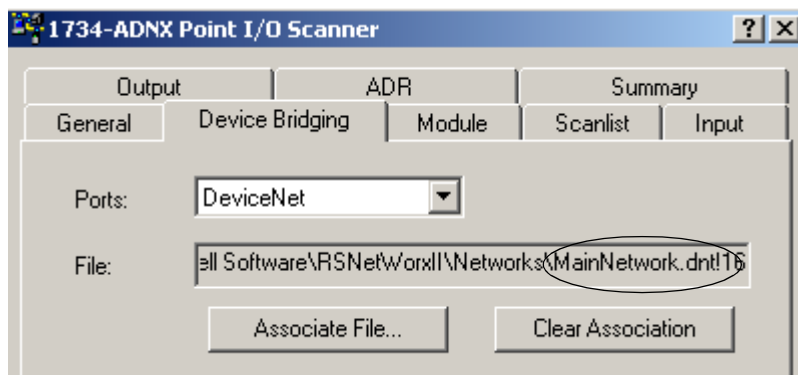

6. Click **OK** to close the properties window.

7.  From the RSNetWorx for DeviceNet main menu, select **File>Save**. Now you can observe how you would switch networks.

Switch Between Networks

1. Move the cursor over the 1734-ADNX in the network browse window:.
2. Press the right mouse button.
3. Click **Associated Network** from the menu.

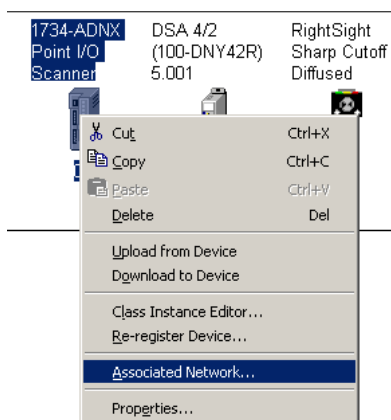

If prompted to save your changes, you must select **Yes** (you will probably not get this prompt if you saved earlier).

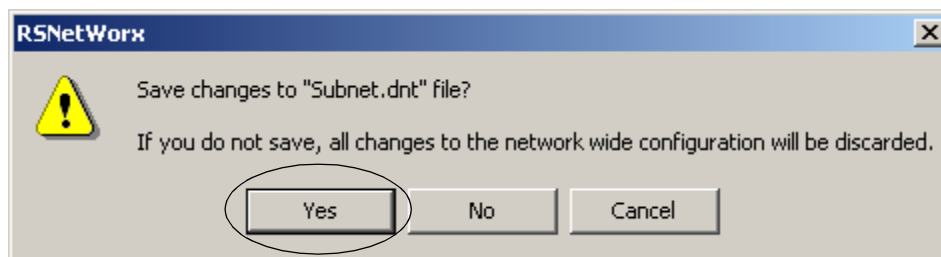

To get back to the main network, associate the **Subnet.dnt** project to **MainNetwork.dnt** using the following steps:

4. Double click on the 1734-ADNX adapter at Node 16.
5. Click the **Device Bridging** tab.

6. Click **Associate File** to associate the **Subnet.dnt** file to the main network.

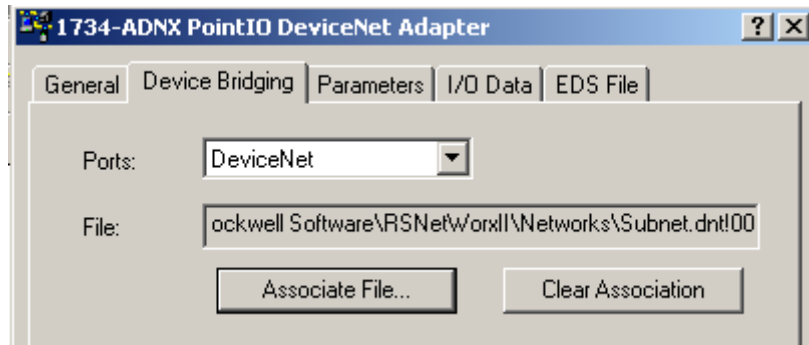

7. Press **OK** (not cancel) to save the association.

Now that they are associated, you can easily jump between the main network and the subnet and vice versa. Another advantage is that the main network has access to the information saved in Subnet.dnt.

8. Click the **Online** icon.

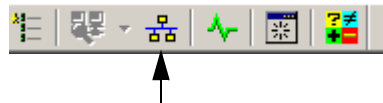

9. When prompted to save, click **Yes**.
10. At the prompt, click **OK**.
11. Let the browse finish then double click on the **1756-DNB** icon to pull up its properties.
12. Click the **Module** tab and if prompted choose **Upload**.

13. Change the slot number to 8 (see illustration below) so it matches the 1756-DNBs location in the 1756-Rack. Then click the **Scanlist** tab.

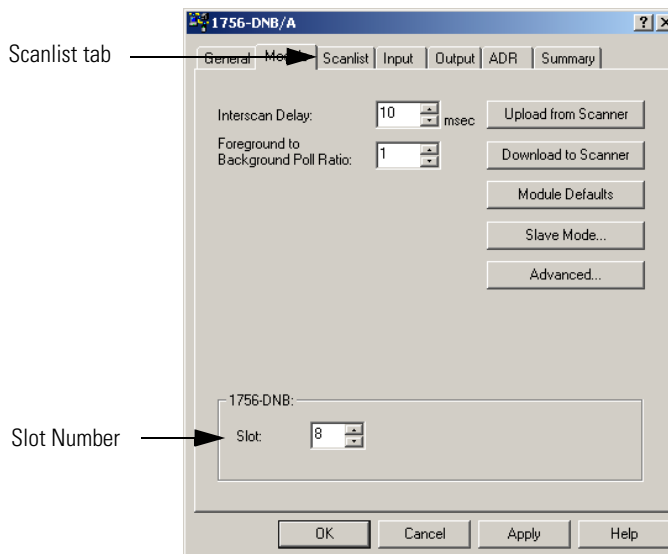

14. Select nodes 1, 15, 16 and 20, then use the single right arrow to add them to your scanlist.
- Notice that you did not get the error message that you received earlier, when you were told that the 1734-ADNX POINT I/O DeviceNet Adapter does not contain any I/O data.
 - When you selected the Edit I/O parameters, you found that no values were filled in the Input and Output fields.
 - Now that you have looked at the Subnet, saved the information, and associated the main network with the Subnet, most of the information is now available from the main network.

You might have more nodes on your DeviceNet Network, but only add 1, 15, 16 and 20 to the scanlist as shown here.

Click to add available devices to scanlist.

Click to download to the scanner.

Edit I/O Parameters button.

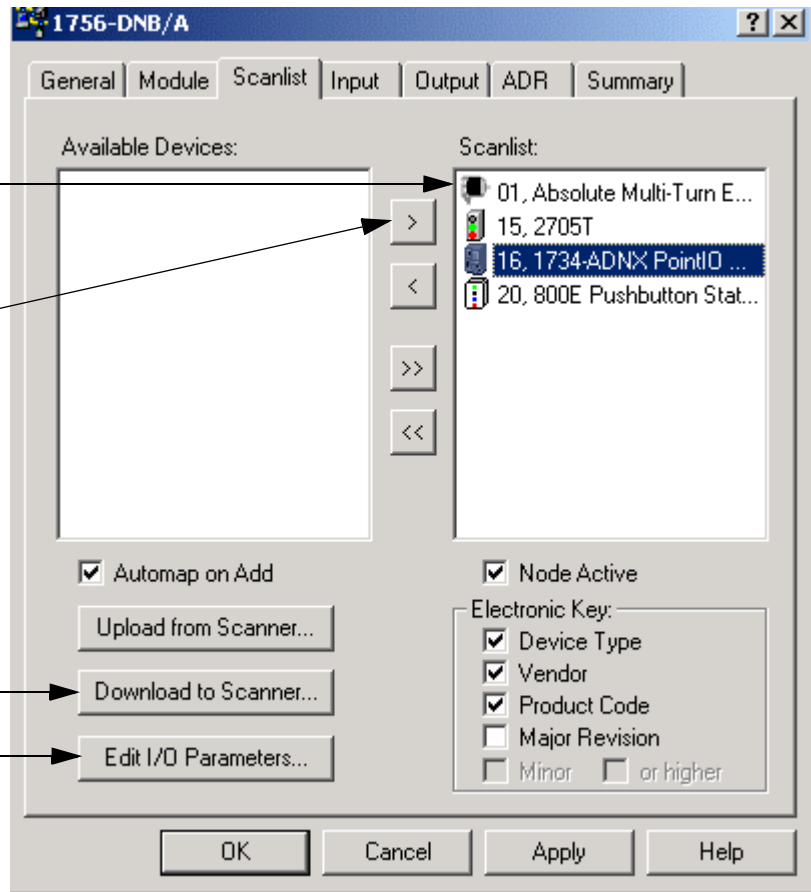

15. Select only the **1734-ADNX** (node 16) then click **Edit I/O Parameters**.

Notice the fields have been filled in for you.

The values match what was observed earlier.

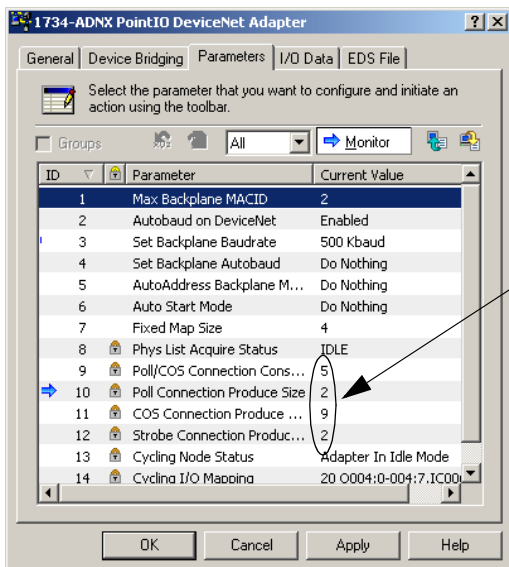

Values observed earlier.

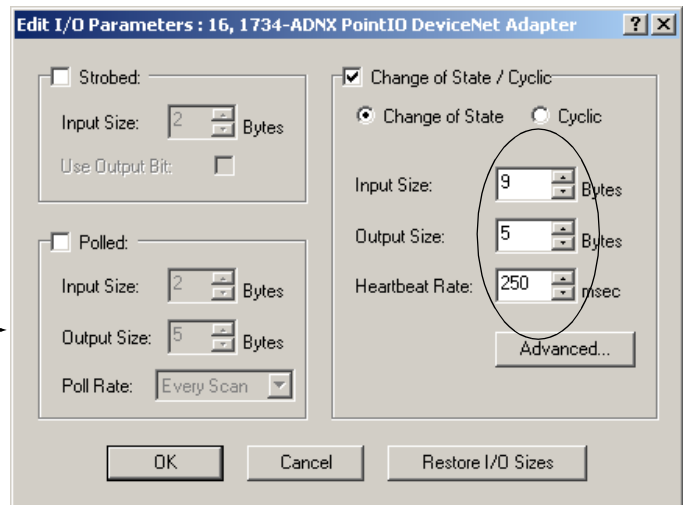

- The 1756-DNB scanner will be receiving 9 bytes of data that the 1734-ADNX produces such as the state of the RightSight.
- The 1756-DNB scanner will be outputting 5 bytes of data that the 1734-ADNX consumes such as the 1734-OB4E outputs.

Sometimes it is easy to get confused and reverse the numbers if these values are entered manually (in this case, entering incorrectly input size = 5 and output size = 9). It is a nice feature that RSNetWorx for DeviceNet fills these values in for you.

- Remember that the RightSight was on the Input tab for the 1734-ADNX Scanner on the Subnet. There were nine bytes total.
- On the main network, the 1734-ADNX is acting as an adapter so it is producing those nine bytes of data for the 1756-DNB. You are now configuring the 1756-DNB, so those nine bytes get filled for Input Size as shown above.

16. Press **Cancel** to close the **Edit I/O Parameters** window.

Now take a look at where the RightSight is mapped so you can use it in our RSLogix5000 program.

17. Click the **Input** tab and expand the plus sign next to the 1734-ADNX.

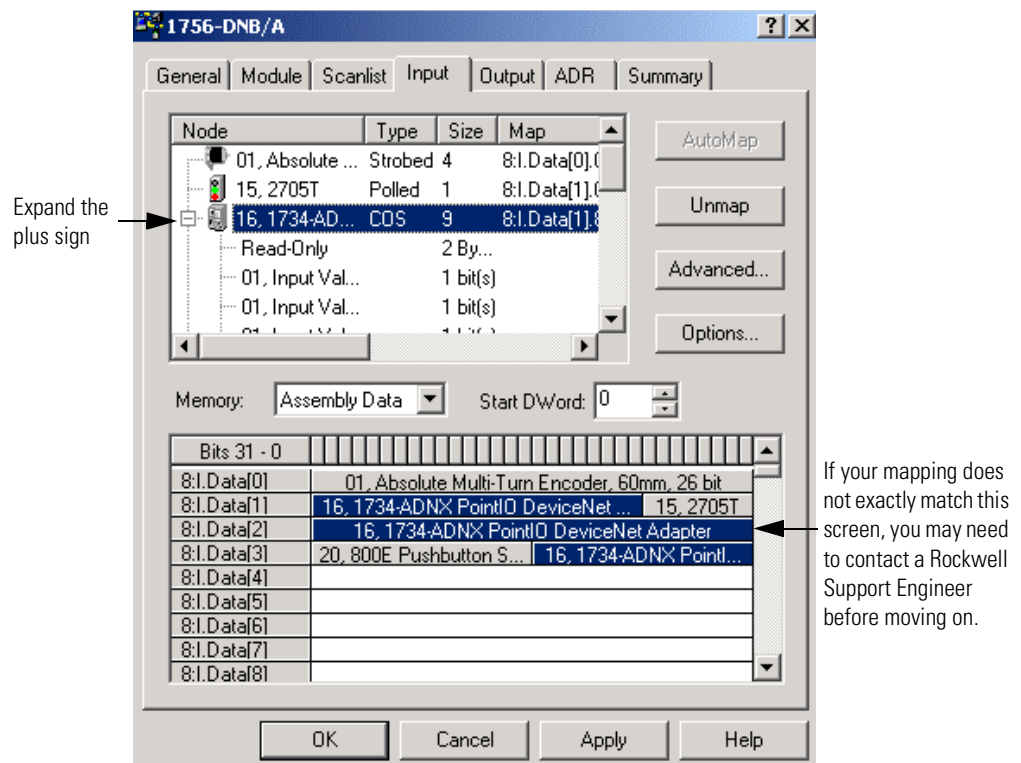

You associated the files, so scroll down until you see the RightSight at node 22 on the subnet.

18. Select the RightSight. Notice that its data is at **8:I.Data[3].8** (it starts at bit 8). You will need that address for our RSLogix5000 program.

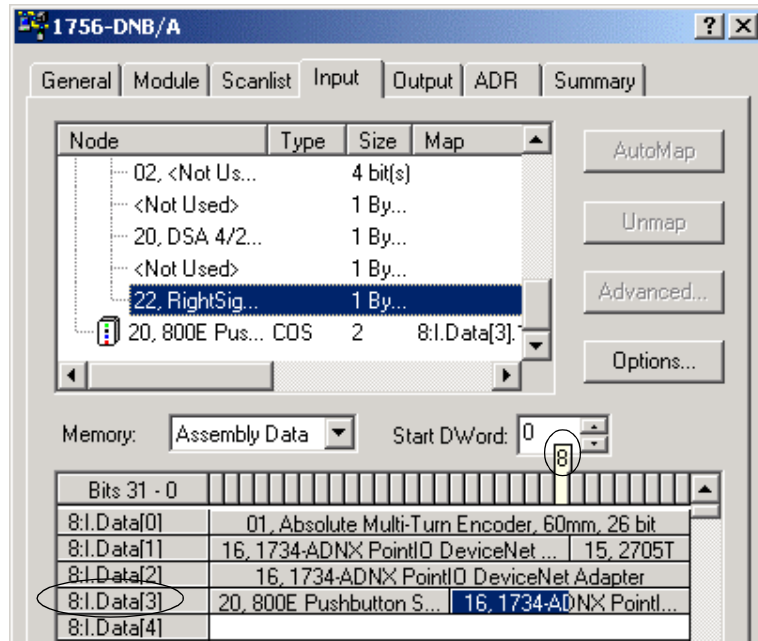

19. Now select the **Output** tab and find the bit for Output Value #1 on the 1734-OB4E. It should be **8:O.Data[0].25** as shown below.

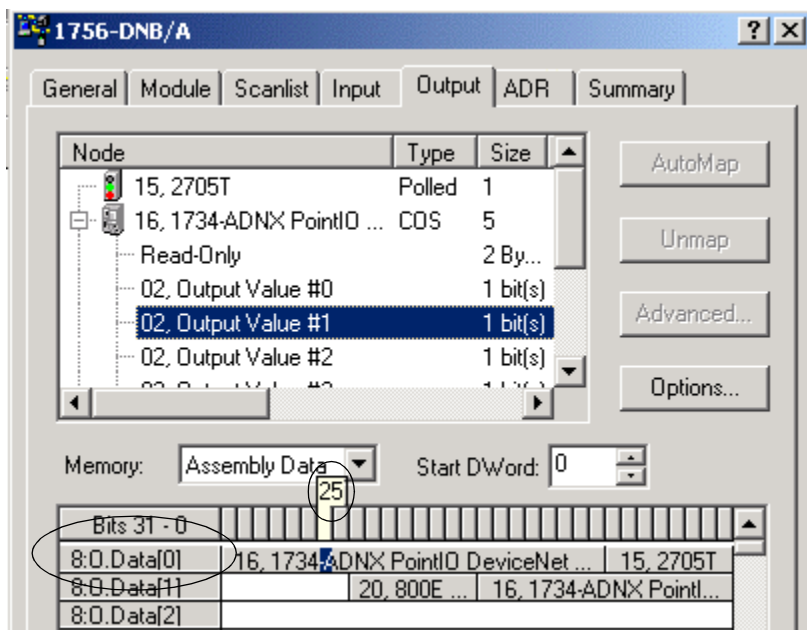

You are now ready to write your RSLogix5000 program.

20. Click **Apply**.
21. Click **Yes** when prompted to download these changes to the device.

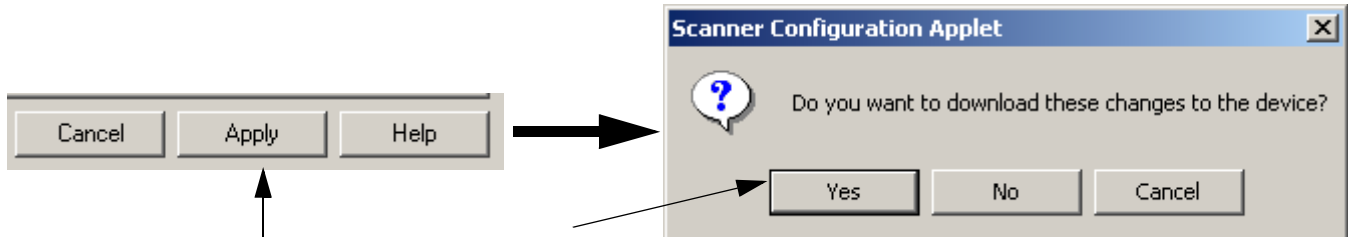

22. Click **OK** to close the 1756-DNB **Output** tab.
23. **Exit** RSNetWorx for DeviceNet.

This is not a necessary step, but it will show you that RSLogix5000 can launch RSNetWorx for DeviceNet

24. When prompted to save, Click **Yes**.

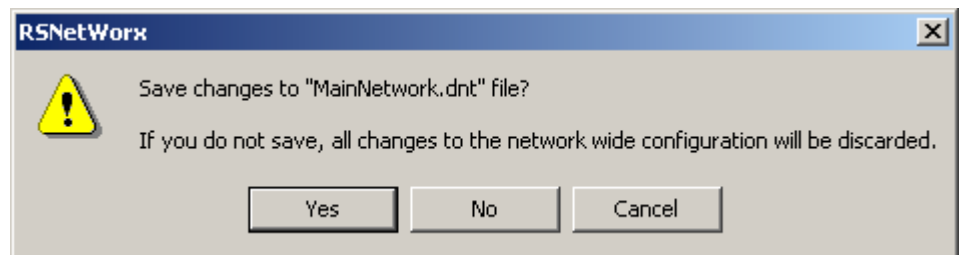

You have completed the 1734-ADNX Quick Start.

Notes:

1734-ADNX Rules and Guidelines Regarding How to Use the 1734-ADNX

RULE 1: A DeviceNet Subnet may not bridge directly to another DeviceNet Subnet. A 1734-ADNX may not be used on the Subnet of another 1734-ADNX.

NOTE: The 1734-ADNX will fault and report an error with any attempt to route message beyond the Subnet. It is not possible, therefore, to send explicit messages or browse through two 1734-ADNX adapters in series or through one 1734-ADNX and a network bridge device (or similar device) in series.

RULE 2: The aggregate sum of the primary DeviceNet trunk and its tributary Subnets cannot exceed the primary DeviceNet trunk scanner's I/O table size. The primary DeviceNet trunk scanner is the primary scanner, which provides data directly to the controller that owns the POINT I/O modules. For a complete list of scanners, refer to the RA Knowledgebase, Document # G32941961.

RULE 3: The 1734-ADNX Subnet is subject to all of the rules of ODVA requirements for DeviceNet compliant devices.

RULE 4: A DeviceNet Subnet may not bridge to any other network. Network is defined in this case as any communication link which is transmitting information from multiple devices to a single channel for further processing and transmission onto a separate network. A 1791D CompactBlock I/O module can be used on the Subnet of a 1734-ADNX, a 1734-ADN cannot be used on the Subnet.

RULE 5: The 1734-ADNX DeviceNet Subnet is comprised of the adapter (always MAC ID 0), any backplane I/O modules and ODVA compliant devices attached to the lower DeviceNet connector.

RULE 6: The 1734-ADNX DeviceNet Subnet must be terminated, like any other DeviceNet network, according to ODVA specifications.

NOTE: Even if no modules are connected to the 2nd DeviceNet connector, the terminating resistors must be inserted into the DeviceNet connector to properly terminate the backplane. See Rockwell Automation publication no. 1734-IN589, for more information.

RULE 7: The EDS parameter, “Max Backplane MACID” must be set to not be lower than that of any backplane modules. If no backplane modules are used, this value can be set to be 0, allowing modules 1-63 to be attached to the Subnet using DeviceNet cable.

RULE 8: Backplane modules are always addressed in increasing order from left to right. Gaps in the backplane addressing are permitted. Empty slots in the backplane are NOT permitted.

RULE 9: Subnet modules not on the backplane must always have or be assigned MAC ID's higher than those of the backplane modules.

RULE 10: Power must be supplied for non-backplane Subnet modules. The 1734-ADNX only supplies power to the backplane POINT I/O modules.

RULE 11: The 1734-ADNX connection sizes may have to be manually entered into the primary DeviceNet network scanner device's scanlist (1756-DNB, 1747-SDN, etc.). Those connection sizes can be read from the EDS parameters 8-11 or deduced from the 1734-ADNX adapter's Subnet I/O mapping.

RULE 12: Explicit message requests will not transmit from the Subnet to the primary DeviceNet trunk. For example, a laptop computer connected to the Subnet with RSLinx will not be able to browse onto the primary DeviceNet.

RULE 13: Any master connected to the subnet cannot own a POINT I/O module on the 1734-ADNX backplane, but can own POINT I/O modules on the subnet that are connected with a 1734-PDN or 1734D POINTBlock.

RULE 14: The 1734-ADNX does not autobaud on the subnet.

Default Data Maps

I/O messages are sent to (consumed) and received from (produced) the POINT I/O modules. These messages are mapped into the processor's memory. This appendix lists the default data maps for 1734 POINT I/O and 1734-POINTBlock modules.

For the default data map of:	See page:
1734-IA2 Input Module	D-2
1734-IB2 Sink Input Module	D-2
1734-IB4 Sink Input Module	D-2
1734-IV2 Source Input Module	D-3
1734-IV4 Source Input Module	D-3
1734-OA2 Output Module	D-3
1734-OB2E Electronically Protected Output Module	D-4
1734-OB2EP Protected Output Module	D-4
1734-OB4E Electronically Protected Output Module	D-4
1734-OV2E Protected Sink Output Module	D-5
1734-OV4E Protected Sink Output Module	D-5
1734-OW2 Relay Sink/Source Output Module	D-6
1734-OX2 Relay Output Module	D-6
1734-IE2C Analog Current Input Module	D-6
1734-IE2V Analog Input Module	D-7
1734-OE2C Analog Current Output Module	D-8
1734-OE2V Analog Output Module	D-8
1734-IJ Encoder/Counter Module	D-9
1734-IK Encoder/Counter Module	D-9
1734-IM2 Input Module	D-10
1734-IR2 RTD Input Module	D-10
1734-IT2I Isolated Thermocouple Input Module	D-11
1734-VHSC 24V dc High Speed Counter Module	D-11
1734-VHSC 5V dc High Speed Counter Module	D-12
1734-SSI Synchronous Serial Interface Absolute Encoder Module	D-12
1734-232ASC ASCII Module	D-13

1734-IA2 Input Module

Message size: 1 Byte

	7	6	5	4	3	2	1	0
Produces (scanner Rx)							Ch1	Ch0
Consumes (scanner Tx)	No consumed data							

Where: Ch0 = channel 0, Ch1 = channel 1; 0 = off, 1 = on

1734-IB2 Sink Input Module

Message size: 1 Byte

	7	6	5	4	3	2	1	0
Produces (scanner Rx)							Ch1	Ch0
Consumes (scanner Tx)	No consumed data							

Where: Ch0 = channel 0, Ch1 = channel 1; 0 = OFF 1 = ON

1734-IB4 Sink Input Module

Message size: 1 Byte

	7	6	5	4	3	2	1	0
Produces (scanner Rx)					Ch3	Ch2	Ch1	Ch0
Consumes (scanner Tx)	No consumed data							

Where: Ch0 = input channel 0 Ch1 = input channel 1 Ch2 = input channel 2 Ch3 = channel 3
0 = OFF 1 = ON

1734-IV2 Source Input Module

Message size: 1 Byte

	7	6	5	4	3	2	1	0
Produces (scanner Rx)							Ch1	Ch0
Consumes (scanner Tx)	No consumed data							

Where: Ch0 = input channel 0 data Ch1 = input channel 1 data

1734-IV4 Source Input Module

Message size: 1 Byte

	7	6	5	4	3	2	1	0
Produces (scanner Rx)					Ch3	Ch1	Ch1	Ch0
Consumes (scanner Tx)	No consumed data							

Where: Ch0 = input channel 0 Ch1 = input channel 1 Ch2 = input channel 2 Ch3 = input channel 3

1734-OA2 Output Module

Message size: 1 Byte

	7	6	5	4	3	2	1	0	
Produces (scanner Rx)	No produced data								
Consumes (scanner Tx)	Not used						Ch1	Ch0	Channel state
Where: 0 = Off, 1 = On									

1734-OB2E Electronically Protected Output Module

Message size: 1 Byte

	7	6	5	4	3	2	1	0	
Produces (scanner Rx)	Not used						Ch1	Ch0	Channel status
Where: 0 = no error 1 = error									

Message size: 1 Byte

	7	6	5	4	3	2	1	0	
Consumes (scanner Tx)	Not used						Ch1	Ch0	Channel state
Where: 0 = OFF 1 = ON									

1734-OB2EP Protected Output Module

Message size: 1 Byte

	7	6	5	4	3	2	1	0	
Produces (scanner Rx)	Not used						Ch1	Ch0	Channel status
Where: 0 = no error 1 = error									

Message size: 1 Byte

	7	6	5	4	3	2	1	0	
Consumes (scanner Tx)	Not used						Ch1	Ch0	Channel state
Where: 0 = OFF 1 = ON									

1734-OB4E Electronically Protected Output Module

Message size: 1 Byte

	7	6	5	4	3	2	1	0	
Produces (scanner Rx)	Not used				Ch3	Ch2	Ch1	Ch0	Channel status
Where: 0 = no error 1 = error									

Message size: 1 Byte

	7	6	5	4	3	2	1	0	
Consumes (scanner Tx)	Not used				Ch3	Ch2	Ch1	Ch0	Channel state

Where: 0 = Off 1 = On

1734-OV2E Protected Sink Output Module*Message size: 1 Byte*

	7	6	5	4	3	2	1	0	
Produces (scanner Rx)	Not used						Ch1	Ch0	Channel status

Where: 0 = no error 1 = error

Message size: 1 Byte

	7	6	5	4	3	2	1	0	
Consumes (scanner Tx)	Not used						Ch1	Ch0	Channel state

Where: 0 = OFF 1 = ON

1734-OV4E Protected Sink Output Module*Message size: 1 Byte*

	7	6	5	4	3	2	1	0	
Produces (scanner Rx)	Not used				Ch3	Ch2	Ch1	Ch0	Channel status

Where: 0 = no error 1 = error

Message size: 1 Byte

	7	6	5	4	3	2	1	0	
Consumes (scanner Tx)	Not used				Ch3	Ch2	Ch1	Ch0	Channel state

Where: 0 = OFF 1 = ON

1734-OW2 Relay Sink/Source Output Module

Message size: 1 Byte

	7	6	5	4	3	2	1	0	
Consumes (scanner Tx)	Not used						Ch1	Ch0	Channel state

Where: 0 = OFF 1 = ON

1734-OX2 Relay Output Module

Message size: 1 Byte

	7	6	5	4	3	2	1	0	
Consumes (scanner Tx)	Not used						Ch1	Ch0	Channel state

Where: 0 = NO contact OFF, NC contact ON1 = NO contact ON, NC contact OFF

1734-IE2C Analog Current Input Module

Message size: 6 Bytes

	15	14	13	12	11	10	09	08	07	06	05	04	03	02	01	00
Produces (scanner Rx)	Input Channel 0 High Byte								Input Channel 0 Low Byte							
	Input Channel 1 High Byte								Input Channel 1 Low Byte							
	Status Byte for Channel 1								Status Byte for Channel 0							
	OR	UR	HHA	LLA	HA	LA	CM	CF	OR	UR	HHA	LLA	HA	LA	CM	CF
Consumes (scanner Tx)	No consumed data															

Where: CF = Channel Fault status0 = no error1 = fault
 CM = Calibration Mode0 = normal1 = calibration mode
 LA = Low Alarm0 = no error1 = fault
 HA = High Alarm0 = no error1 = fault
 LLA = Low/Low Alarm0 = no error1 = fault
 HHA = High/High Alarm0 = no error1 = fault
 UN = Underrange0 = no error1 = fault
 OR = Overage0 = no error1 = fault

Channel Status

Table D.A
Channel Status Byte

Bit 7	Bit 6	Bit 5	Bit 4	Bit 3	Bit 2	Bit 1	Bit 0
Over Range	Under Range	High High Alarm	Low Low Alarm	High Alarm	Low Alarm	CAL Mode	Channel Fault

1734-IE2V Analog Input Module

Message size: 6 Bytes

	15	14	13	12	11	10	09	08	07	06	05	04	03	02	01	00
Produces (scanner Rx)	Input Channel 0 - High Byte								Input Channel 0 - Low Byte							
	Input Channel 1 - High Byte								Input Channel 1 - Low Byte							
	Status Byte for Channel 1								Status Byte for Channel 0							
	OR	UR	HHA	L LA	HA	LA	CM	CF	OR	UR	HHA	L LA	HA	LA	CM	CF
Consumes (scanner Tx)	No consumed data															

Where: CF = Channel Fault status; 0 = no error, 1 = fault
 CM = Calibration Mode; 0 = normal, 1 = calibration mode
 LA = Low Alarm; 0 = no error, 1 = fault
 HA = High Alarm; 0 = no error, 1 = fault
 LLA = Low/Low Alarm; 0 = no error, 1 = fault
 HHA = High/High Alarm; 0 = no error, 1 = fault
 UR = Underrange; 0 = no error, 1 = fault
 OR = Overage; 0 = no error, 1 = fault

1734-OE2C Analog Current Output Module

Message size: 4 bytes

	15	14	13	12	11	10	09	08	07	06	05	04	03	02	01	00
Consumes (Tx)	Output Channel 0 High Byte								Output Channel 0 Low Byte							
	Output Channel 1 High Byte								Output Channel 1 Low Byte							

Message size: 2 Bytes

	15	14	13	12	11	10	09	08	07	06	05	04	03	02	01	00
Produces (Rx)	High Byte - Channel 1 Status								Low Byte - Channel 0 Status							
	Not used				HCA	LCA	CM	CF	Not used				HCA	LCA	CM	CF

Where: CF = Channel Fault status 0 = no error 1 = fault
 CM = Calibration Mode 0 = normal 1 = calibration mode
 LCA = Low Clamp Alarm 0 = no error 1 = fault
 HCA = High Clamp Alarm 0 = no error 1 = fault

Channel Status

Table D.B
Channel Status Byte

Bit 7	Bit 6	Bit 5	Bit 4	Bit 3	Bit 2	Bit 1	Bit 0
Not used				High Clamp	Low Clamp	CAL Mode	Channel Fault

1734-OE2V Analog Output Module

Message size: 2 Bytes

	15	14	13	12	11	10	09	08	07	06	05	04	03	02	01	00
Produces (scanner Rx)	Channel 1 Status - High Byte								Channel 0 Status - Low Byte							
	Not used				HCA	LCA	CM	ST	Not used				HCA	LCA	CM	ST

Where: ST = Channel Fault Status; 0 = no error, 1 = fault
 CM = Calibration Mode; 0 = normal, 1 = calibration mode
 LCA = Low Clamp Alarm; 0 = no error, 1 = fault
 HCA = High Clamp Alarm; 0 = no error, 1 = fault

1734-IJ Encoder/Counter Module

Message size: 6 Bytes

	15	14	13	12	11	10	09	08	07	06	05	04	03	02	01	00
Produces (scanner Rx)	Channel 0 value of present counter state (LSW)															
	Channel 0 value of present counter state (MSW)															
	PE	EF	NR	0	0	0	0	0	0	0	ZS	BS	AS	C1	C0	ZD

Where: PE = Programming error
 EF = EEPROM fault status
 NR = Not ready status bit
 ZS = Z input status
 BS = B input status
 AS = A input status
 C = Stored data count
 ZD = Zero frequency detected
 LSW = Least significant word
 MSW = Most significant word

1734-IK Encoder/Counter Module

Message size: 6 Bytes

	15	14	13	12	11	10	09	08	07	06	05	04	03	02	01	00
Produces (scanner Rx)	Channel 0 value of present counter state (LSW)															
	Channel 0 value of present counter state (MSW)															
	PE	EF	NR	0	0	0	0	0	0	0	ZS	BS	AS	C1	C0	ZD

Where: PE = Programming error
 EF = EEPROM fault status
 NR = Not ready status bit
 ZS = Z input status
 BS = B input status
 AS = A input status
 C = Stored data count
 ZD = Zero frequency detected
 LSW = Least significant word
 MSW = Most significant word

1734-IM2 Input Module

Message size: 1 Byte

	7	6	5	4	3	2	1	0
Produces (Rx)							Ch1	Ch0
Consumes (Tx)	No consumed data							

Where: Ch0 = channel 0, Ch1 = channel 1; 0 = off, 1 = on

1734-IR2 RTD Input Module

Message size: 6 Bytes

	15	14	13	12	11	10	09	08	07	06	05	04	03	02	01	00
Produces (scanner Rx)	Input Channel 0 - High Byte								Input Channel 0 - Low Byte							
	Input Channel 1 - High Byte								Input Channel 1 - Low Byte							
	Status Byte for Channel 1								Status Byte for Channel 0							
	OR	UR	HHA	L LA	HA	LA	CM	CF	OR	UR	HHA	L LA	HA	LA	CM	CF
Consumes (scanner Tx)	No consumed data															

Where: CF = Channel Fault status; 0 = no error, 1 = fault
 CM = Calibration Mode; 0 = normal, 1 = calibration mode
 LA = Low Alarm; 0 = no error, 1 = fault
 HA = High Alarm; 0 = no error, 1 = fault
 LLA = Low/Low Alarm; 0 = no error, 1 = fault
 HHA = High/High Alarm; 0 = no error, 1 = fault
 UR = Underrange; 0 = no error, 1 = fault
 OR = Overrange; 0 = no error, 1 = fault

1734-IT2I Isolated Thermocouple Input Module

Message size: 8 Bytes

	15	14	13	12	11	10	09	08	07	06	05	04	03	02	01	00
Produces (scanner Rx)	Input Channel 0 - High Byte								Input Channel 0 - Low Byte							
	Input Channel 1 - High Byte								Input Channel 1 - Low Byte							
	Status Byte for Channel 1								Status Byte for Channel 0							
	OR	UR	HHA	L LA	HA	LA	CM	CF	OR	UR	HHA	L LA	HA	LA	CM	CF
	OR	UR	Cold Junction Temperature (Selectable: Channel 0, Channel 1, or Average of both Channel 0 and 1)													
Consumes (scanner Tx)	No consumed data															

Where: CF = Channel Fault status; 0 = no error, 1 = fault
 CM = Calibration Mode; 0 = normal, 1 = calibration mode
 LA = Low Alarm; 0 = no error, 1 = fault
 HA = High Alarm; 0 = no error, 1 = fault
 LLA = Low/Low Alarm; 0 = no error, 1 = fault
 HHA = High/High Alarm; 0 = no error, 1 = fault
 UR = Underrange; 0 = no error, 1 = fault
 OR = Overrange; 0 = no error, 1 = fault

1734-VHSC 24V dc High Speed Counter Module

Message size: 6 Bytes

	15	14	13	12	11	10	09	08	07	06	05	04	03	02	01	00
Produces (scanner Rx)	Channel 0 value of present counter state (LSW)															
	Channel 0 value of present counter state (MSW)															
	PE	EF	NR	0	FS	FS	OS	OS	0	ZS	BS	AS	C1	C0	ZD	0

Where: PE = Programming error
 EF = EEPROM fault status
 NR = Not ready status bit
 FS = Output fault status bit - bit 10 for output 0, bit 11 for output 1
 OS = Output on/off status bit - bit 8 for output 0, bit 9 for output 1
 ZS = Z input status
 BS = B input status
 AS = A input status
 C = Stored data count
 ZD = Zero frequency detected
 LSW = Least significant word
 MSW = Most significant word

1734-VHSC 5V dc High Speed Counter Module

Message size: 6 Bytes

	15	14	13	12	11	10	09	08	07	06	05	04	03	02	01	00
Produces (scanner Rx)	Channel 0 value of present counter state (LSW)															
	Channel 0 value of present counter state (MSW)															
	PE	EF	NR	0	FS	FS	OS	OS	0	ZS	BS	AS	C1	C0	ZD	0

Where: PE = Programming error
 EF = EEPROM fault status
 NR = Not ready status bit
 FS = Output fault status bit - bit 10 for output 0, bit 11 for output 1
 OS = Output on/off status bit - bit 8 for output 0, bit 9 for output 1
 ZS = Z input status
 BS = B input status
 AS = A input status
 C = Stored data count
 ZD = Zero frequency detected
 LSW = Least significant word
 MSW = Most significant word

1734-SSI Synchronous Serial Interface Absolute Encoder Module

	7	6	5	4	3	2	1	0	
Produce 8	C2ST	C1ST	C2R	C1R	INC	DEC	RUN	I1	Status Byte 0 ¹
Produce 9	RES	RES	RES	LHON	IDF ²	CCE	CCF	SPF	Status Byte 1 ¹

- For detailed descriptions of these bits, see 1734-SSI User Manual, publication 1734-UM009.
- Monitor IDF to determine the validity of the produced data. If IDF=1, the SSI data is false.

	7	6	5	4	3	2	1	0	
Consume 0	RES	RES	RES	SCMP2	SCMP1	CC2	CC1	LACK	Master ACK Byte ¹
Consume 1	RES	RES	RES	RES	RES	RES	RES	RES	CONS1

- The master must provide the Master ACK Byte in order to receive the polled Produced bytes 0-9.

1734-232ASC ASCII Module*Default Receive Data Assembly Format (Default Mode)*

Byte 1	Byte 2	Byte 3	Byte 4	Byte 5-23	Byte 24
Rx Transaction ID Byte	Status Byte	Reserved	Length	ASCII Data	<CR> (Terminator)

Default Transmit Data Assembly Format (Default Mode)

Byte 1	Byte 2	Byte 3	Byte 4	Byte 5-23	Byte 24
Reserved	TX Transaction ID Byte	Reserved	Length	ASCII Data	<CR> (Terminator)

Numbers

1734-232ASC data map D-13

1734-ADNX

guidelines on how to use C-1

rules on how to use C-1

1734-ADNX MAC ID parameters

rules B-9

1734-ADNX quick start

review auto start mode B-11

assumptions B-1

browse the subnet B-15

inputs and outputs B-18

navigate between networks B-23

review 1734-ADNX MAC ID parameters
B-9

review 1734-ADNX rules B-9

switch between networks B-25

1734-ADNX rules

review D-9

1734-IA2 data map D-2

1734-IB2 data map D-2

1734-IB4 data map D-2

1734-IE2C data map D-6

1734-IE2V data map D-7

1734-IJ data map D-9

1734-IK data map D-9

1734-IM2 data map D-10

1734-IR2 data map D-10

1734-IT2I data map D-11

1734-IV2 data map D-3

1734-IV4 data map D-3

1734-OA2 data map D-3

1734-OB2E data map D-4

1734-OB2EP data map D-4

1734-OB4E data map D-4, D-5

1734-OE2C data map D-8

1734-OE2V data map D-8

1734-OV2E data map D-5

1734-OV4E data map D-5

1734-OW2 data map D-6, D-12

1734-OX2 data map D-6

1734-SSI data map D-12

1734-VHSC24 data map D-11

1734-VHSC5 data map D-12

A

adapter

residence on two networks
simultaneously 2-2

using 2-2

what it is? 2-1

adapter features

auto address 2-13

automatic device replacement 2-15

backplane autobaud 2-12

backplane baudrate 2-10

COS connection produce size 2-14

expected packet rate 2-17

field upgradable firmware 2-8

foreground to background poll ratio 2-17

fully software configurable 2-8

interscan delay 2-17

multiple baudrates 2-9

multiple connection types 2-9

physical list acquire status 2-13

physical ordering 2-16

poll/COS connection consume size 2-14

poll/COS connection produce size 2-14

self-test 2-8

strobe connection produce size 2-14

transmit retries 2-18

assumptions during quick start B-1

audience for manual Preface-1

auto address 2-13

enabling in RSNNetWorx for DeviceNet
2-13

auto catalog replace 2-10

auto start mode 2-9, B-1

review B-11

autobaud Preface-5, 2-9

automatic device replacement 2-15, 2-18

B

backplane autobaud 2-12

enabling in RSNNetWorx for DeviceNet
2-12

backplane baudrate 2-10

setting in RSNNetWorx for DeviceNet
2-11

baudrate 2-9

browse the subnet B-15

C

change bars Summary of Changes-1

Change of State (COS) 5-5

change of state (COS) 2-6, 2-22

channel status byte, analog input modules, description D-7

collecting data on PointBus 2-7

communications

communicating with I/O modules 2-22
 image table mapping 2-20
 mapping data 2-18
 overview of the process 2-19

configuration

adding I/O modules to your network 4-3
 adding the adapter to your network 4-2
 adding the scanner to your network 4-2
 configuring the adapter for DeviceNet 4-1
 configuring the adapter for PointBus 2-4
 going online 4-8, 5-6
 RSNNetWorx for DeviceNet 1-3,
 Preface-4
 setting the adapter's parameters 4-3
 setting the scanner's parameters 4-3
 using EDS files 4-5

connections

to and from the adapter 2-9

contents of manual Preface-2

ControlFlash Preface-3, 2-8

conventions used in manual Preface-6

COS connection produce size 2-14

cyclic 2-6, 2-22

cycling I/O mapping 2-15

cycling node status 2-14

D

data collection

on PointBus 2-7

data maps

1734-232ASC D-13
 1734-IA2 D-2
 1734-IB2 D-2
 1734-IB4 D-2
 1734-IE2C D-6
 1734-IE2V D-7
 1734-IJ D-9
 1734-IK D-9
 1734-IM2 D-10
 1734-IR2 D-10
 1734-IT2I D-11
 1734-IV2 D-3
 1734-IV4 D-3
 1734-OA2 D-3
 1734-OB2E D-4
 1734-OB2EP D-4
 1734-OB4E D-4, D-5
 1734-OE2C D-8
 1734-OE2V D-8
 1734-OV2E D-5

1734-OV4E D-5
 1734-OW2 D-6, D-12
 1734-OX2 D-6
 1734-SSI D-12
 1734-VHSC24 D-11
 1734-VHSC5 D-12
 default D-1

data tables

faulted node table 2-23
 idle node table 2-23

data tablesnode status table 2-23

default data maps D-1

DeviceNet Communications

Change of state 5-5
 Polled 2-6
 Strobe 2-6

DeviceNet communications

backplane autobaud 2-12
 backplane baudrate 2-10
 change of state 2-6, 2-22
 cyclic 2-6, 2-22
 polled 2-6, 2-22
 strobe 2-6, 2-22

DeviceNet network 2-2, 5-6

diagnositc tables 2-23

documentation

for other POINT I/O products Preface-5

documentation related to POINT I/O

products Preface-5

E

EDS Files 5-5

expansion power unit (1734-EP24DC) 2-8

expected packet rate 2-17

setting in RSNNetWorx for DeviceNet 4-5

F

faulted node table 2-23

firmware

upgrading in the field 2-8

foreground to background poll ratio 2-17

setting in RSNNetWorx for DeviceNet 4-5

G

going online 4-8, 5-6

guidelines for using the adapter

Preface-5

guidelines on how to use 1734-ADNX C-1

I

- I/O status word bit** 2-21
- idle node table** 2-23
- image table mapping** 2-20
- important user information** 2
- inputs and outputs tab** 2-18
- installing I/O modules** 3-8
- installing the adapter** 1-1, 1-4
- interscan delay** 2-17
 - setting in RSNetWorx for DeviceNet 4-5

M

- map from parameters**
 - setting in RSNetWorx for DeviceNet 4-6
- mapping I/O data**
 - in auto start mode 3-3
- module changes**
 - automatic device replacement 2-15
- module power** 2-7

N

- navigate between networks** 2-23
- networks** 2-2
 - DeviceNet 5-6, 2-18
 - PointBus 2-18
- new and revised information** Summary of Changes-1
- node status**
 - cycling 2-14
- node status table** 2-23

P

- physical list acquire status** 2-13
- physical ordering** 2-16
- PointBus** 2-2
 - data collection 2-7
- poll/COS connection consume size** 2-14
- poll/COS connection produce size** 2-14
- Polled** 2-6
- polled** 2-6, 2-22
- power**
 - expansion power unit 2-8
 - supplying power to POINT I/O modules 2-7
- products related to POINT I/O products** Preface-5
- purpose of manual** Preface-1

Q

- quick start**
 - 1734-ADNX B-1

R

- related documentation** Preface-5
- related products** Preface-5
- remove and reinsert modules on DeviceNet network** 2-5
- replacing an Existing Adapter** 1-4
- review 1734-ADNX MAC ID parameters** B-9
- review 1734-ADNX rules** B-9
- RSNetWorx for DeviceNet** Preface-4, 3-2, 3-10, 4-1, 5-1
- RSNetWorx for DeviceNet software** 1-3
- rules on how to use 1734-ADNX** C-1

S

- self-test**
 - of adapter at power-up 2-8
- Software**
 - RSNetWorx for DeviceNet 1-3, Preface-4
- software**
 - Configuring the adapter for PointBus 2-4
 - configuring the adapter for DeviceNet 2-4
 - RSNetWorx for DeviceNet 2-8, 3-10
- specifications** A-1
- status byte, analog output module** D-8
- status indicators** 6-1
- Strobe** 2-6
- strobe** 2-6, 2-22
- strobe connection produce size** 2-14
- summary of changes** Summary of Changes-1
 - change bars Summary of Changes-1
 - new and revised information Summary of Changes-1
- switch between networks** 2-25

T

- Terminal Marking Kits** Preface-6
- terms defined** Preface-3
- trademark information** 2
- transmit retries** 2-18
 - setting in RSNetWorx for DeviceNet 2-5

troubleshooting
using status indicators 6-1

U

updating adapter firmware
using the ControlFlash utility Preface-3
using diagnostic tables 2-23

using the adapter
guidelines Preface-5

W

who should use manual Preface-1
wiring the adapter 3-7



How Are We Doing?

Your comments on our technical publications will help us serve you better in the future. Thank you for taking the time to provide us feedback.

You can complete this form and mail it back to us, visit us online at www.ab.com/manuals, or email us at RADocumentComments@ra.rockwell.com

Pub. Title/Type POINT I/O DeviceNet Adapter

Cat. No. 1734-ADN, 1734-ADNX Pub. No. 1734-UM002C-EN-P Pub. Date July 2003 Part No. 957831-02

Please complete the sections below. Where applicable, rank the feature (1=needs improvement, 2=satisfactory, and 3=outstanding).

Overall Usefulness 1 2 3	How can we make this publication more useful for you?		
Completeness (all necessary information is provided) 1 2 3	Can we add more information to help you?		
	procedure/step	illustration	feature
	example	guideline	other
	explanation	definition	
Technical Accuracy (all provided information is correct) 1 2 3	Can we be more accurate?		
	text	illustration	
Clarity (all provided information is easy to understand) 1 2 3	How can we make things clearer?		
Other Comments	You can add additional comments on the back of this form.		

Your Name _____
Your Title/Function _____

Location/Phone _____

Would you like us to contact you regarding your comments?
___ No, there is no need to contact me
___ Yes, please call me
___ Yes, please email me at _____
___ Yes, please contact me via _____

Return this form to: Allen-Bradley Marketing Communications, 1 Allen-Bradley Dr., Mayfield Hts., OH 44124-9705
Phone: 440-646-3176 Fax: 440-646-3525 Email: RADocumentComments@ra.rockwell.com

PLEASE FASTEN HERE (DO NOT STAPLE)

Other Comments

PLEASE FOLD HERE

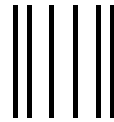

NO POSTAGE
NECESSARY
IF MAILED
IN THE
UNITED STATES

PLEASE REMOVE

BUSINESS REPLY MAIL

FIRST-CLASS MAIL PERMIT NO. 18235 CLEVELAND OH

POSTAGE WILL BE PAID BY THE ADDRESSEE



**Rockwell
Automation**

1 ALLEN-BRADLEY DR
MAYFIELD HEIGHTS OH 44124-9705

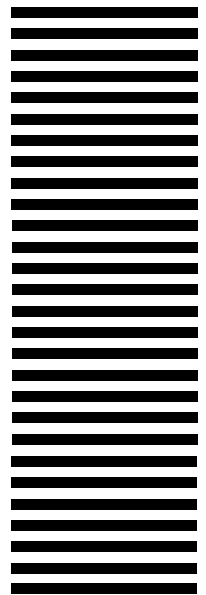

Rockwell Automation Support

Rockwell Automation provides technical information on the web to assist you in using our products. At <http://support.rockwellautomation.com>, you can find technical manuals, a knowledge base of FAQs, technical and application notes, sample code and links to software service packs, and a MySupport feature that you can customize to make the best use of these tools.

For an additional level of technical phone support for installation, configuration and troubleshooting, we offer TechConnect Support programs. For more information, contact your local distributor or Rockwell Automation representative, or visit <http://support.rockwellautomation.com>.

Installation Assistance

If you experience a problem with a hardware module within the first 24 hours of installation, please review the information that's contained in this manual. You can also contact a special Customer Support number for initial help in getting your module up and running:

United States	1.440.646.3223 Monday – Friday, 8am – 5pm EST
Outside United States	Please contact your local Rockwell Automation representative for any technical support issues.

New Product Satisfaction Return

Rockwell tests all of our products to ensure that they are fully operational when shipped from the manufacturing facility. However, if your product is not functioning and needs to be returned:

United States	Contact your distributor. You must provide a Customer Support case number (see phone number above to obtain one) to your distributor in order to complete the return process.
Outside United States	Please contact your local Rockwell Automation representative for return procedure.

www.rockwellautomation.com

Power, Control and Information Solutions Headquarters

Americas: Rockwell Automation, 1201 South Second Street, Milwaukee, WI 53204-2496 USA, Tel: (1) 414.382.2000, Fax: (1) 414.382.4444

Europe/Middle East/Africa: Rockwell Automation, Vorstlaan/Boulevard du Souverain 36, 1170 Brussels, Belgium, Tel: (32) 2 663 0600, Fax: (32) 2 663 0640

Asia Pacific: Rockwell Automation, Level 14, Core F, Cyberport 3, 100 Cyberport Road, Hong Kong, Tel: (852) 2887 4788, Fax: (852) 2508 1846

Publication 1734-UM002C-EN-P - July 2003

Supersedes Publication 1734-UM002B-EN-P - June 2001

PN 957831-02

Copyright © 2003 Rockwell Automation, Inc. All rights reserved. Printed in the U.S.A.